

RONDA startech 5000

Chronographs, Big Date & Date,
different calendar systems, Alarm

Caliber 5021.D – 12½'''

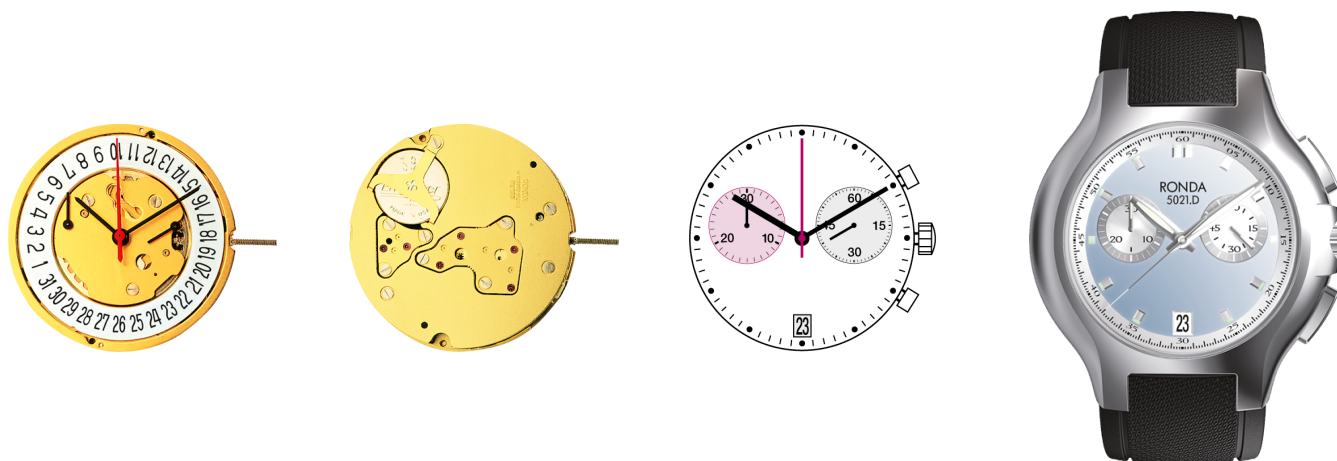

Product Specifications

Analog quartz movement

Line

startech

Caliber

5021.D

Size

12½'''

Version Swiss Made
Swiss Parts

10 Jewels / gold plated
5 Jewels / nickel plated

Standard battery life

54 months

Hand fitting height

1

Features

- Repairable metal watch movement
- Very long battery life
- Power saving mechanism with pulled out stem: Reduction of consumption approximately 70%
- Very easy handling by two pushers

Functions

- 2 eyes
- Chronograph
- Center stop second (1/1 sec)
- 30 minute counter
- ADD and SPLIT functions
- Date
- Small second

Technical Specifications

Diameter Total	28.60 mm
Case fitting	28.00 mm
Movement height	4.40 mm
Height over standard battery	4.40 mm
Movement rest	0.60 mm
Height over stem	1.90 mm
Length of stem travel	0.90 mm
Force to push the stem for screwed crown	10 / 15 N
Stem thread	0.90 mm
Standard battery	395
Standard battery life	54 months
Battery voltage	1.5 V
Current consumption – typical	1.32 µA (Date Mechanism not in Gear)
Current consumption – maximum	1.65 µA (Date Mechanism not in Gear)
Useful torque second – typical	6 µNm
Useful torque minute – typical	300 µNm
Useful torque center stop second – typical	7 µNm
Operating temperature	0 - 50 °C
Instantaneous rate	-10/ +20 sec/month
Resistance to magnetic fields	18.8 Oe
Resistance against shock	NIHS 91-10



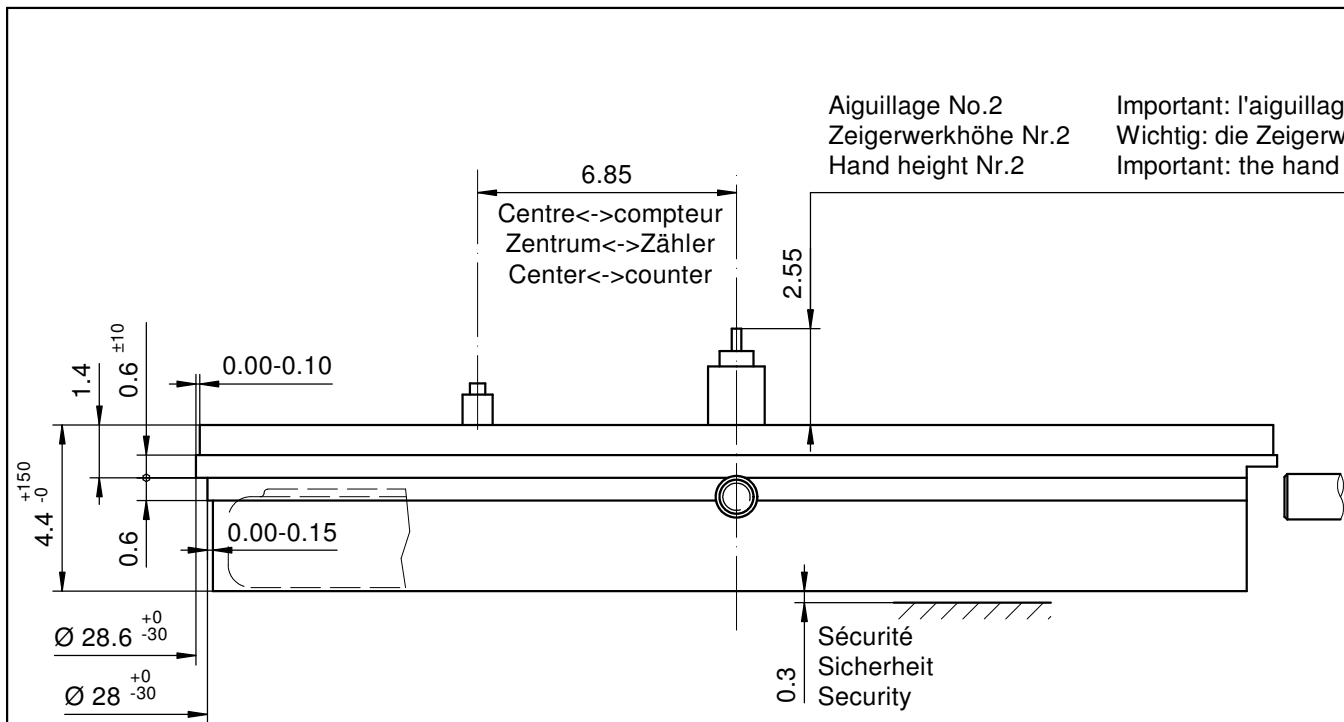

Aiguillage No.2
Zeigerwerkhöhe Nr.2
Hand height Nr.2

Important: l'aiguillage peut varier selon le modèle
Wichtig: die Zeigerwerkhöhe kann bei verschiedenen Modellen unterschiedlich sein
Important: the hand height can vary between different models

Sécurité entre l'aiguille des secondes et le verre: 0.30mm
Sicherheit zwischen Sekundenzeiger und Glas: 0.30mm
Security between second hand and glass:

Le cadran doit être tenu par la boîte
Das Zifferblatt muss durch die Schale gehalten werden
The dial must be hold by the case

La course du poussoir doit être limitée dans le poussoir lui-même. Sa position poussée doit être contrôlée.

Die Weglänge des Drückers ist im Drücker selbst zu begrenzen. In der gedrückten Stellung ist seine Position zu kontrollieren

The way of the pusher has to be limited in the pusher itself. Its position must be checked while pushed in.

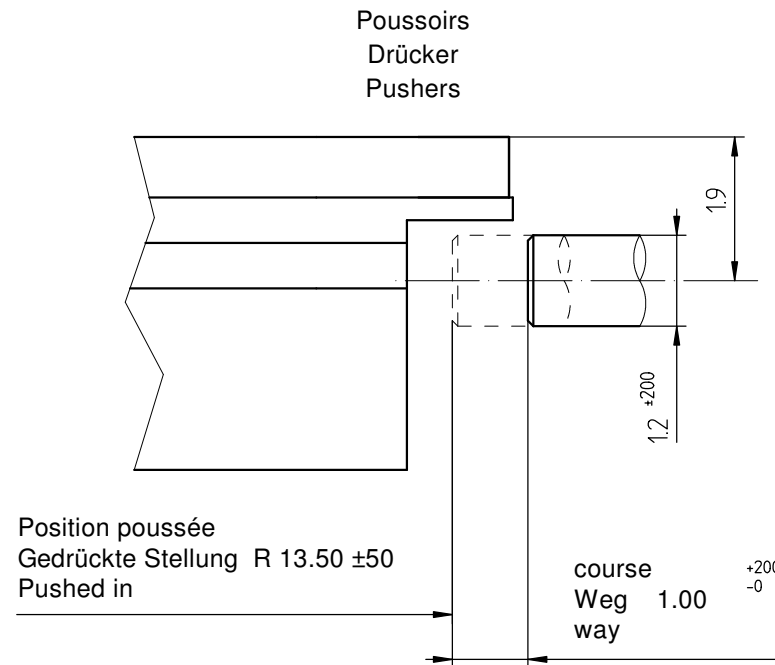

Côté fond de boîte
Seite Gehäuseboden
Case back side
Position pour extraire la tige
Position zum Entfernen der Stellwelle
Position to remove the stem

Pile Batterie (395) Ø 9.50 x 2.60mm
Battery

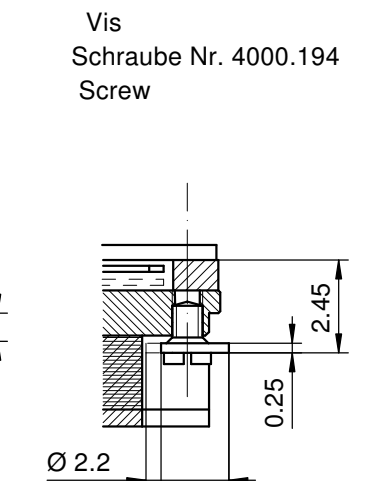
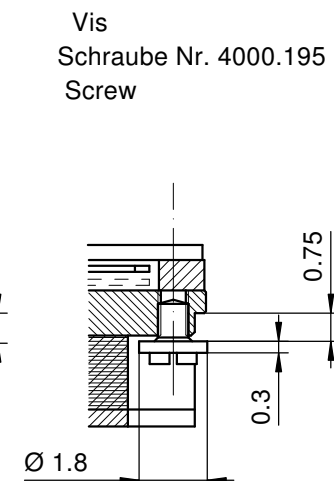
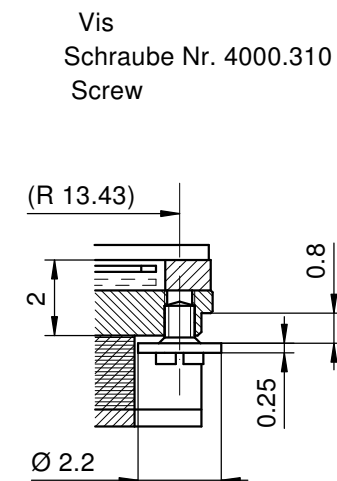
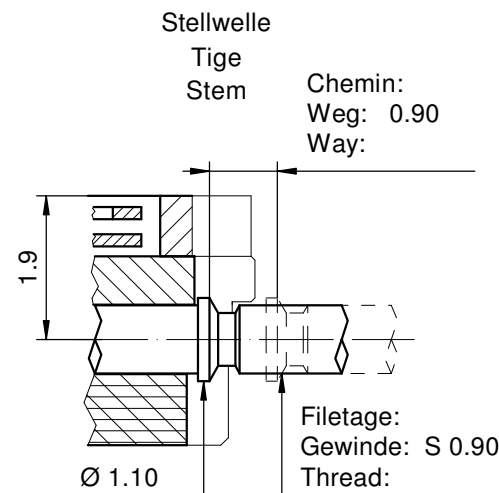
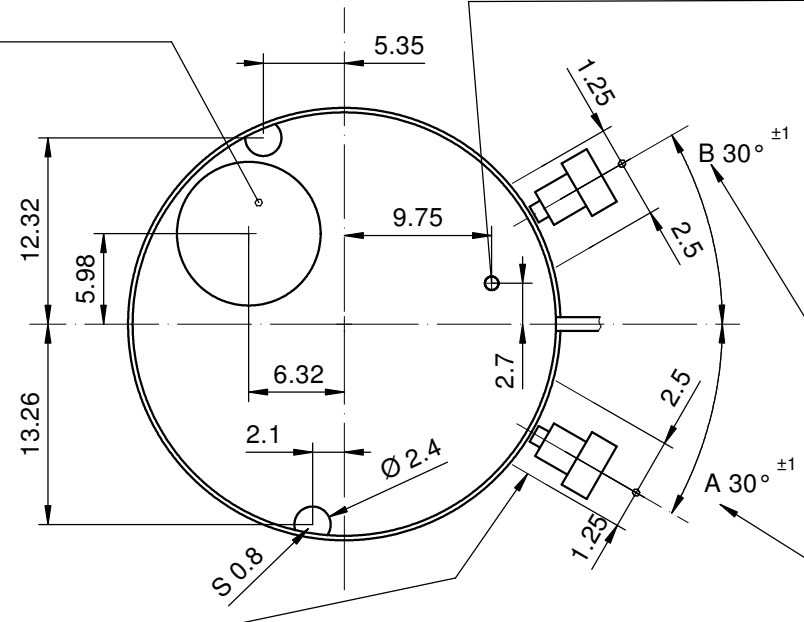

Dégagement cercle d'entourage pour poussoir
Freistellung Gehäuseering für Drücker
Opening movement holder for pusher

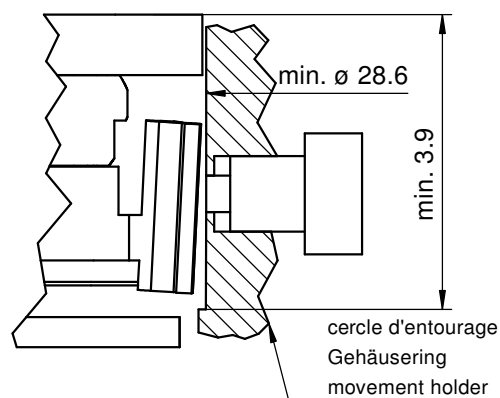

L'angle indiqué pour la direction du poussoir et la position doivent être respectés.
Pour un angle de 0° des poussoirs A et B, voir plan 5000.345

Der angegebene Winkel für die Drückerrichtung und die Position müssen eingehalten werden.
Für einen Drückerwinkel von 0° bei A und B, siehe Zeichnung 5000.345

The indicated angle of the pusher direction and the position must be fulfilled. For pusher angles of 0° (pusher A and B), see drawing 5000.345.

Cage
Uhrwerkgestell 12½"
Frame

RONDA 5040.B, 5040.D, 5030.D, 5021.D, 5040.E

Issued	08 Jan 2001	mg
Modified	31 Aug 2016 ÅA 34777	dh
Released	YES	
Tolerance	+/- 20 µm	
Scale	10 : 1 (5 : 1) (A3H)	
Sous réserve de modifications Änderungen vorbehalten Modifications reserved		
No.	5000.315	10

Angle Winkel Angle	30°	
Ø Dp	b	
1.00	13.50	
1.10	13.50	
1.20	13.50	
1.30	13.50	
1.40	13.50	

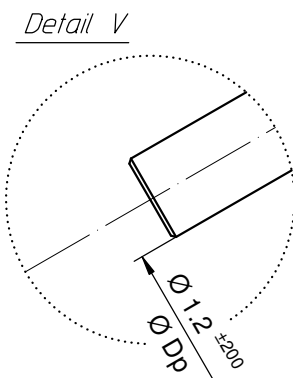
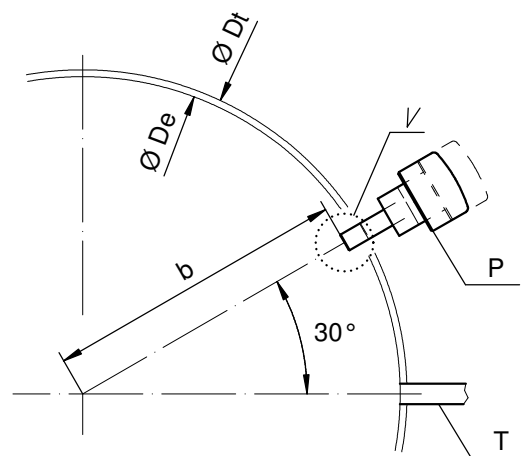

Angle Winkel Angle	0°	
Ø Dp	a	b
1.30	7.40	11.43
1.40	7.45	11.40

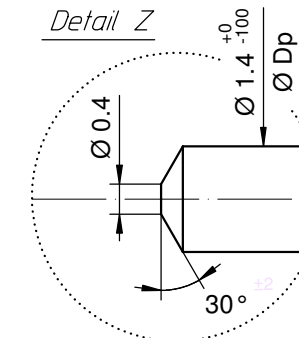
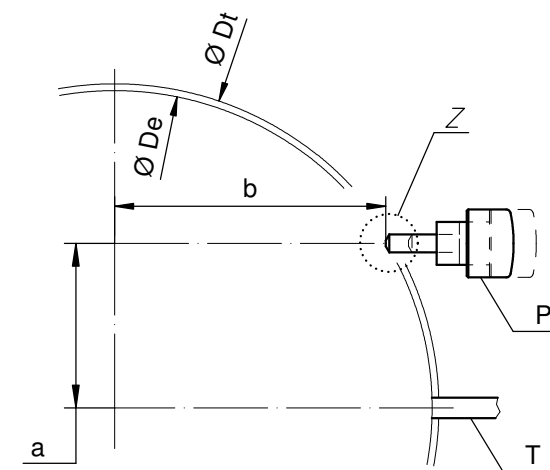

Angle Winkel Angle	20°	
Ø Dp	a	b
1.30	2.57	13.22
1.40	2.59	13.21

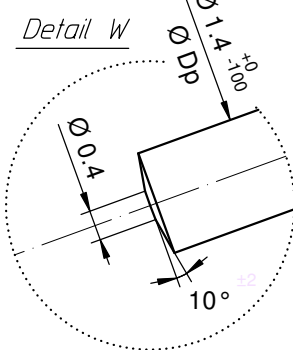
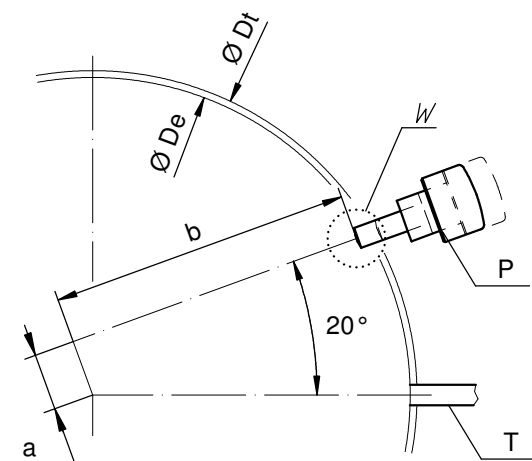

Ø De: diamètre d'encageage
Durchmesser der Gehäusepassung
fitting-diameter

Ø Dp: diamètre du poussoir
Drückerdurchmesser
pusher-diameter

Ø Dt: diamètre total
Totaldurchmesser
total-diameter

P: poussoir en position poussée
Drücker in gedrückter Stellung
pusher in pressed position

T: tige de mise à l'heure
Stellwelle
stem

Angle Winkel Angle	15°	
Ø Dp	a	b
1.30	3.83	12.92
1.40	3.86	12.91

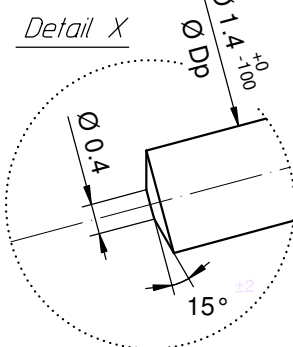
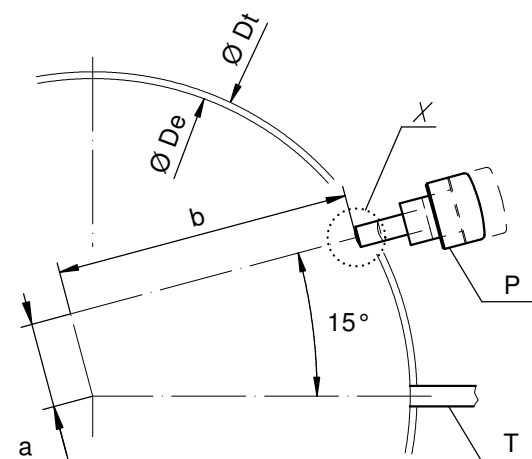

Angle Winkel Angle	10°	
Ø Dp	a	b
1.30	5.06	12.52
1.40	5.10	12.50

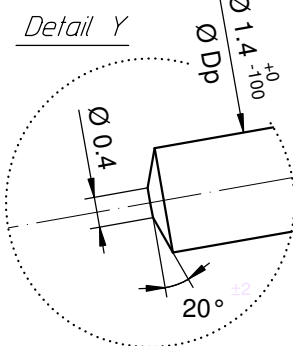
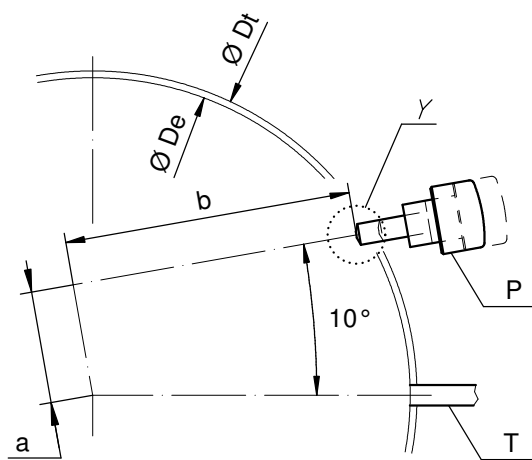

Angle des poussoirs A et B
Winkel der Drücker A und B
Angle of pusher A and B

RONDA 4xxx.x, 5xxx.x

Issued	06 Sep 2004	mk
Modified	30.März 2005 ÄA 1784	mk
Released	YES	
Tolerance	+/- 20 µm	
Scale	10 : 1 (5 : 1) (A3H)	
Sous réserve de modifications Änderungen vorbehalten Modifications reserved		
No.	5000.345	01

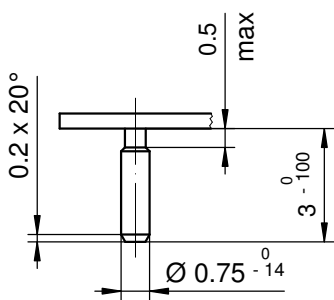
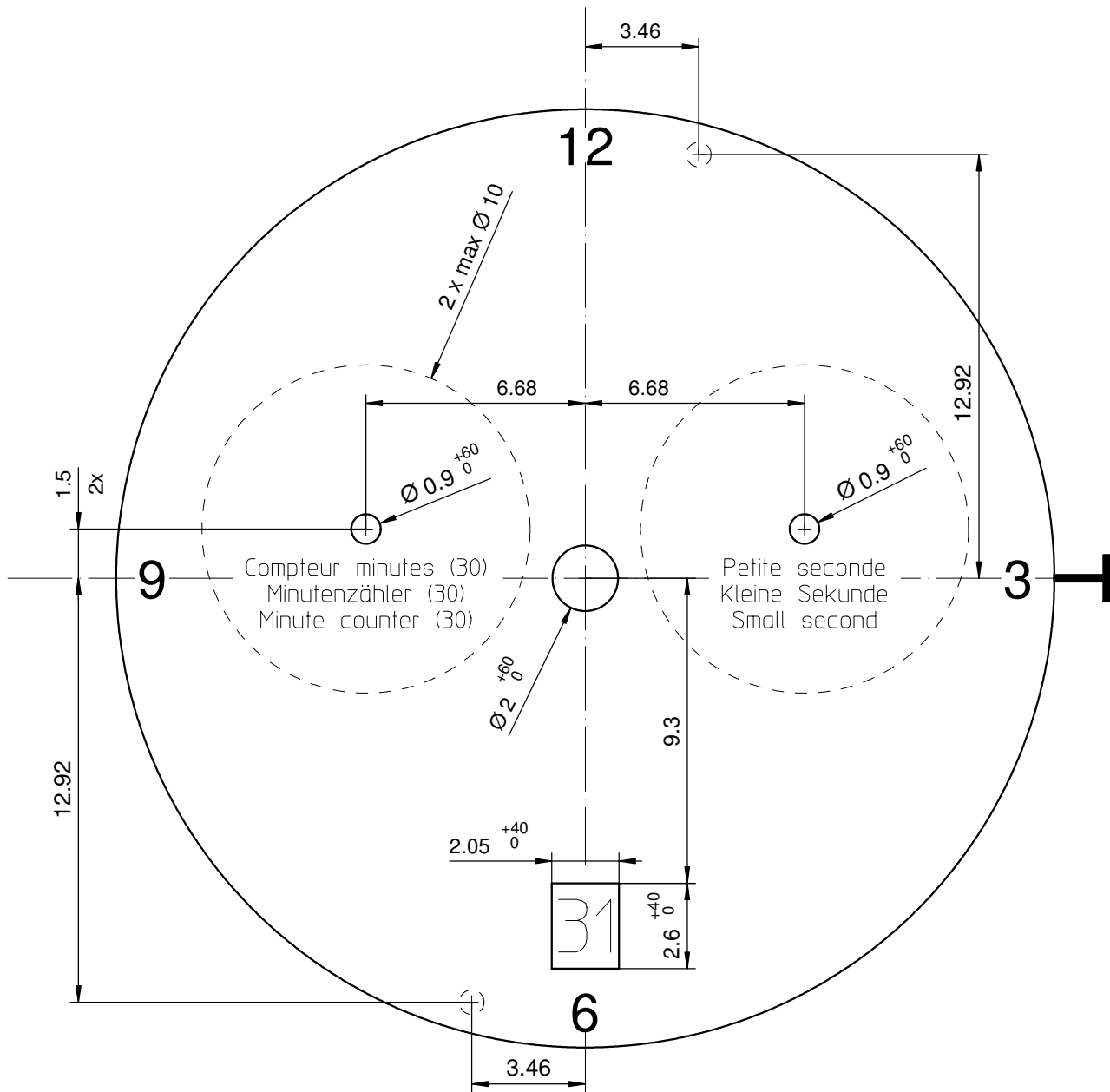

Epaisseur du cadran selon hauteur de l'aiguillage
 Zifferblattdicke gemäss Zeigerwerkhöhen
 Dial thickness according to hand fitting heights

Tige	Date
Stellw.	Datum
Stem	Date
3H	6H

Cadran Zifferblatt Dial	12 1/2"	Issued	14 Sep 2003	mk
		Modified	21 Feb 2011 ÄA 10543	dh
		Released	YES	
		Tolerance	+/- 20 µm	
		Scale	5 : 1 (A4V)	
RONDA	5021.D	Sous réserve de modifications Aenderungsvorbehalten Modifications reserved		
		No.	5010.657	02

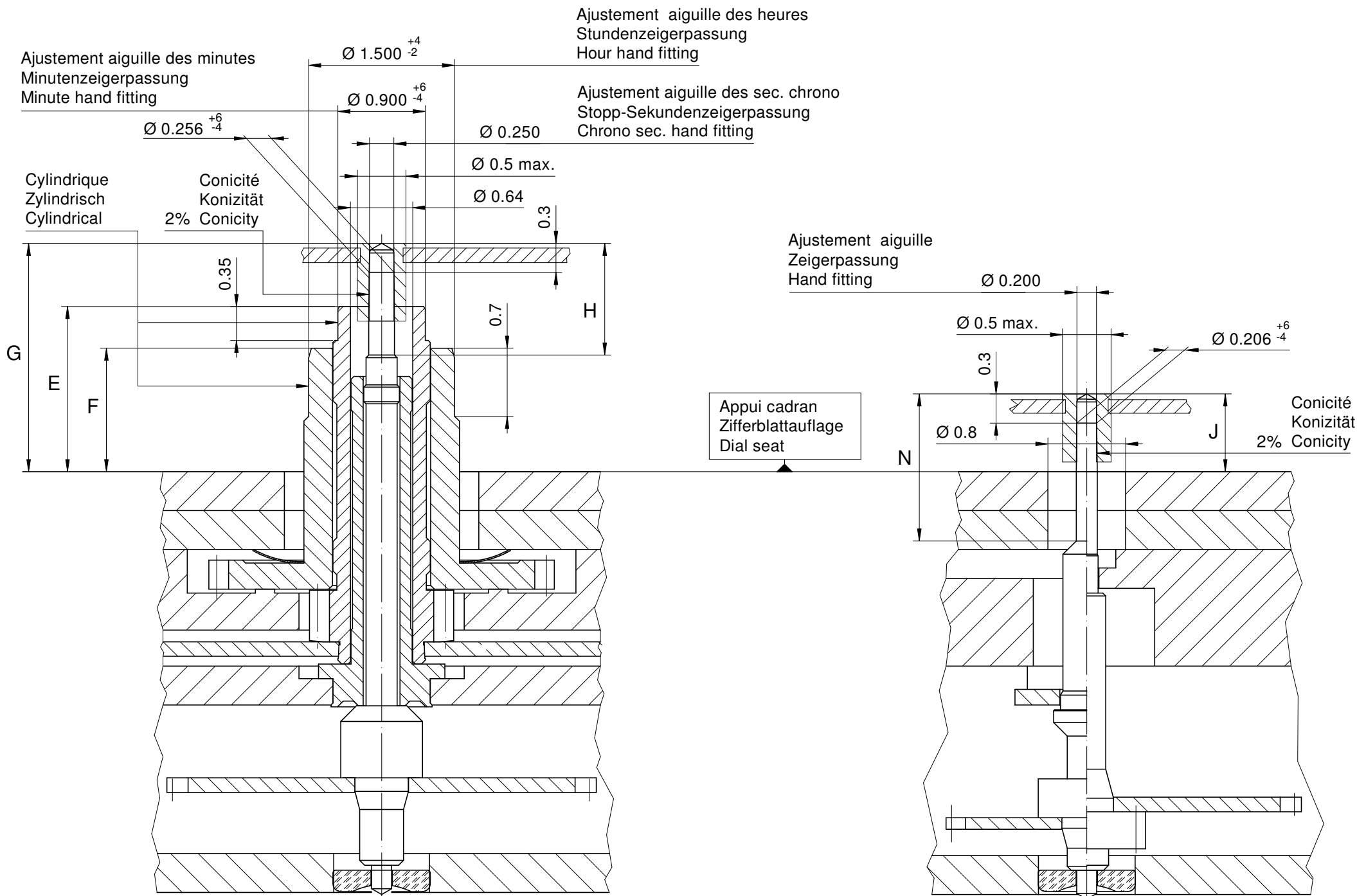

Heures / minutes / secondes chrono
 Stunden / Minuten / Stopp-Sekunden
 Hours / minutes / chrono second

Compteur 1 aiguille / 1 Zeiger Zähler / 1 Hand counter
 Petite seconde / Kleine Sekunde / Small second

Aiguillages Zeigerwerkhöhe Hand fitting height							
Dépassement Höhe über Zifferblattauflage Height over dial seat							
No	G	E	F	H	N	J	J
1	2.35	1.70	1.27	1.15	1.50	0.80	0.80
-							

Aiguillages Zeigerwerkhöhe Hand fitting height						
Peinture comprise / inkl. Farbe / Paint included						
Epaisseur maximum du cadran Maximale Zifferblattstärke Maximum dial thickness						
No	Sous l'aiguille des secondes chrono Unter Stopp-Sekundenzeiger Under chrono second hand	Sous l'aiguille des minutes Unter Minutenzeiger Under minute hand	Sous l'aiguille des heures Unter Stundenzeiger Under hour hand	Sous l'aiguille de petite seconde Unter kleine Sekundenzeiger Under small second hand	Sous l'aiguille compteur 1 aiguille Unter Zeiger 1 Zeiger Zähler Under hand 1 hand counter	Epaisseur des aiguilles Zeigerdicke Hands thickness
1	1.85	1.30	0.85	0.40	0.40	0.15
-						

	Aig. des sec. chrono Stopp-Sekundenzeiger Chrono second hand	Aig. des minutes Minutenzeiger Minute hand	Aig. des heures Stundenzeiger Hour hand	Aig. petite secondes Kleine Sekundenzeiger Small second hand	Aiguille compteur (1 aig.) Zähler Zeiger (1 Zeiger) Counter hand (1 hand)	
mg max.	10	30	30	10	10	Masse / Masse / Weight *
µNm max.	0.06	0.80	0.80	0.07	0.03	Balourd / Unwucht / Unbalance *
gmm ² max.	1.0	-	-	0.4	-	Inertie / Massenträgheit / Inertia *
N max.	30	40	40	30	30	Force de chassage / Aufpresskraft / Force

Lors de la pose d'aiguilles, le mouvement doit être soutenu.
 Beim Zeigersetzen muss das Werk abgestützt werden.
 The movement needs to be supported for hand setting.

<h2>Aiguillages Zeigerwerkhöhen 12½" Hand fitting heights</h2>		Issued	21 Feb 2011	dh
		Modified	15 Okt 2014 ÄÄ 13275	dh
		Released	Yes	
		Tolerance	µm	
		Scale	20 : 1 (A3H)	
<h3>RONDA 5021.D</h3>		Sous réserve de modifications Änderungen vorbehalten Modifications reserved		
		No.	3316.146	01

* En cas de données différentes, veuillez contacter le service après-vente * Bei abweichenden Werten, bitte technischen Kundendienst anfragen * In case of different values, please contact the customer service

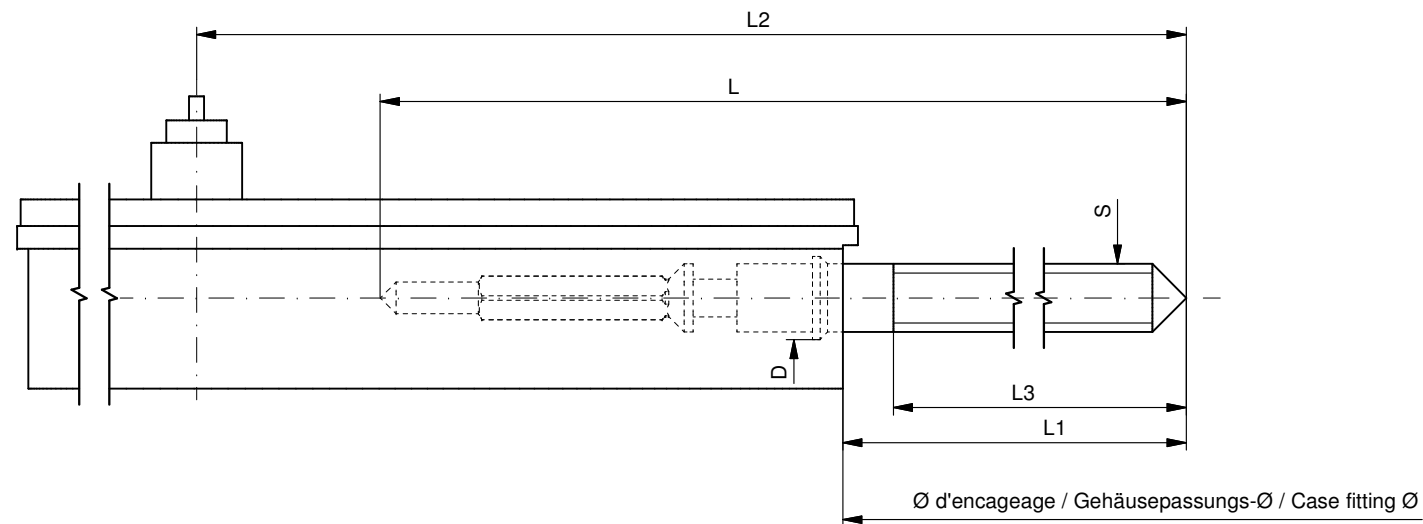

Tige de travail (intégrée dans le mouvement)
 Arbeitstellwelle (im Werk eingebaut)
 Working stem (implemented in the movement)

No. d'article Artikelnummer Part number	L	L1	L2	L3	S	D
3000.177.CO	20.00	10.23	24.23	10.15	0.90	1.10

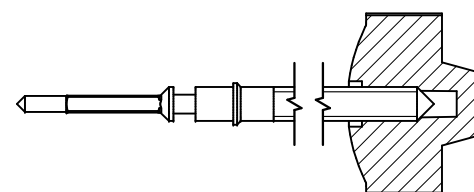

Couleur de la couronne Kronenfarbe Crown color	bleu foncé dunkelblau dark blue
Code	UN 5002

Tige (normale) / Stellwelle (normal) / Stem (normal)

No. d'article Artikelnummer Part number	L	L1	L2	L3	S	D
3000.177	20.00	10.23	24.23	10.15	0.90	1.10
3000.191	32.00	22.23	36.23	22.15	0.90	1.10

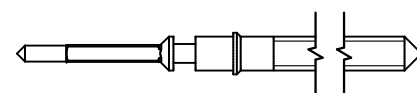

Couronne normale
 Normale Krone
 Normal crown

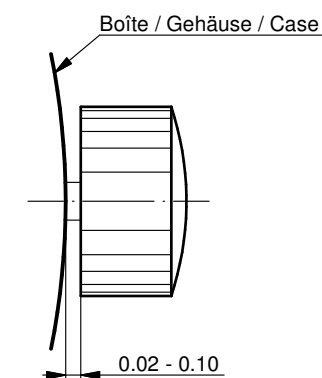

Couronne vissée
 Geschraubte Krone
 Screwed crown

Force ⇐ min. Kraft ⇐ min. Force ⇐ min.	10 N
Force ⇐ max. Kraft ⇐ max. Force ⇐ max.	15 N

Rallonge de tige / Stellwelle Verlängerung / Stem extension

No. d'article Artikelnummer Part number	L4	L5 (min)	L6	S1	S2	D1
3000.040	12.00	1.90	2.60	0.90	0.90	1.35

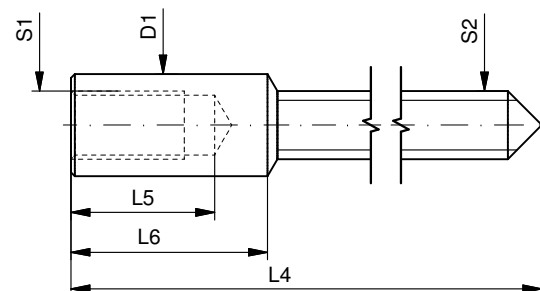

Tige (dimensions / forces)
 Stellwelle (Dimensionen / Kräfte)
 Stem (dimensions / forces)

RONDA

5010.B, 5020.B, 5021.D, 5030.D,
 5040.B, 5040.D, 5040.E, 5040.F,
 5050.B, 5050.C, 5051.C, 5130.B, 5130.D

Issued	05 Sep 2012	ds5222
Modified	17 Mär 2017 ÄA 34582	mg5224
Released	YES	
Tolerance	---	
Scale	10:1 (A3)	

Sous réserve de modifications
 Änderungen vorbehalten
 Modifications reserved

No.	5030.019	01
-----	----------	----



Movement holder
Removing setting stem
H5XXX.1T



Movement holder
Setting hands
H5XXX.1A

Fitting dial and hands

- Crown in position III
- Wind crown, until date 02 appears
- Crown in position III
- Wind hour hand forwards, until date changes to 03
- Remove working stem
- Fit dial
- Point all hands towards 12 o'clock
- Set time
- Zero chronograph hand*
- Crown in position II
- Set date
- Crown in position I

Date switching duration:

~1¼hrs

***Zeroing the Chronograph hand**

- A. Activate pushers A and B for 2 seconds at the same time
(Chrono seconds hand rotates once)
- B. Pusher A → to corrects chrono seconds hand
- C. Pusher B → to make minute and seconds hand jump
- D. Pusher A → to correct hand position

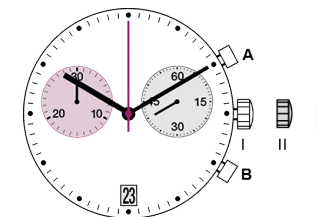
General Instructions

Removing the setting stem can only be effected in Pos. I.

The use of supporting screws is essential when mounting the hands.

Permitted hand setting strengths:

Hr / min. hands: <40N

Other hands: <30N

During quick date correction (setting stem in position II), a date switching speed of 5 d/s must not be exceeded.

You have decided to buy a watch, which was assembled by a watchmaker using a Ronda movement. Please note that no watches are produced or distributed under the Ronda Brand.

In case of repairs, guarantee claims and questions concerning the functioning of a watch, purchasers and consumers should contact their retailer or the watch manufacturer, for which the relevant information can be found in the sales or guarantee documentation provided with the watch.

Description of the display and control buttons

Display elements

Second hand
Minute hand
Hour hand
Second counter
Minute counter
Hour counter (only 5030.D)
Date 5021.B
Date 5030.D

Control buttons

Push button A
Crown
Push button B

01

05

Chronograph: Basic function

(Start / Stop / Reset)

Example:

- Start:** Press push-button A.
- Stop:** To stop the timing, press push-button A once more and read the chronograph hands: **1h / 20min / 38 sec.**
- Zero positioning:** Press push-button B. (The chronograph hands will be reset to their zero positions.)

05

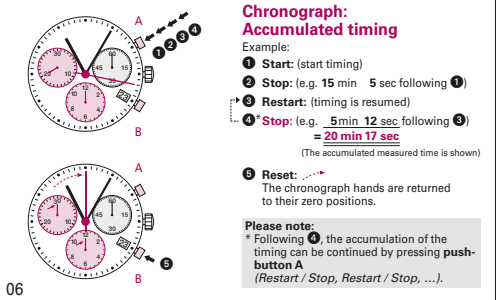
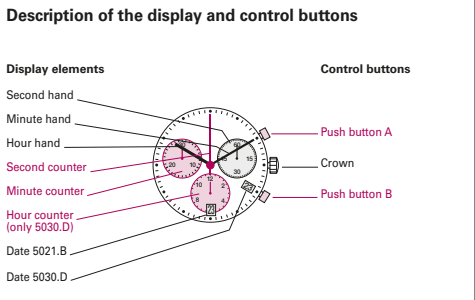

Chronograph: Accumulated timing

Example:

- Start:** (start timing)
- Stop:** (e.g. 15 min 5 sec following 1)
- Restart:** (timing is resumed)
- Stop:** (e.g. 5 min 12 sec following 3) = **20 min 17 sec** (The accumulated measured time is shown)
- Reset:** The chronograph hands are returned to their zero positions.

Please note:

* Following 2, the accumulation of the timing can be continued by pressing **push-button A** (Restart / Stop, Restart / Stop, ...).

06

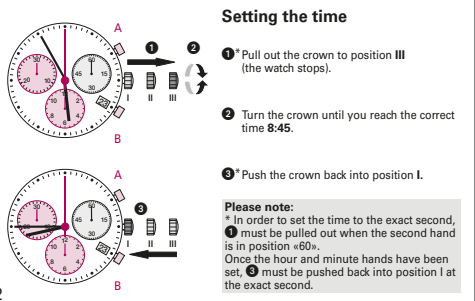

Setting the time

- Pull out the crown to position III (the watch stops).
- Turn the crown until you reach the correct time 8:45.
- Push the crown back into position I.

Please note:

* In order to set the time to the exact second, 1 must be pulled out when the second hand is in position «60». Once the hour and minute hands have been set, 2 must be pushed back into position I at the exact second.

02

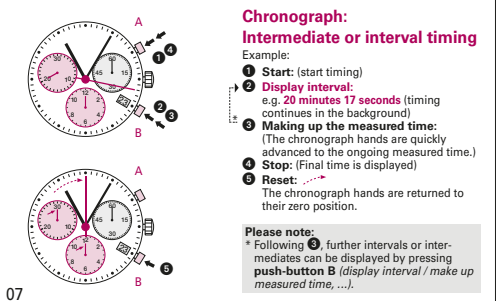

Chronograph: Intermediate or interval timing

Example:

- Start:** (start timing)
- Display interval:** e.g. 20 minutes 17 seconds (timing continues in the background)
- Making up the measured time:** (The chronograph hands are quickly advanced to the ongoing measured time.)
- Stop:** (Final time is displayed)
- Reset:** The chronograph hands are returned to their zero position.

Please note:

* Following 2, further intervals or intermediates can be displayed by pressing **push-button B** (display interval / make up measured time, ...).

07

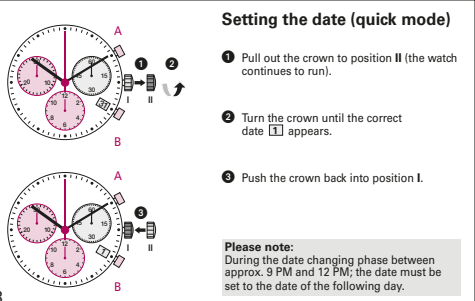

Setting the date (quick mode)

- Pull out the crown to position II (the watch continues to run).
- Turn the crown until the correct date [1] appears.
- Push the crown back into position I.

Please note:

During the date changing phase between approx. 9 PM and 12 PM, the date must be set to the date of the following day.

03

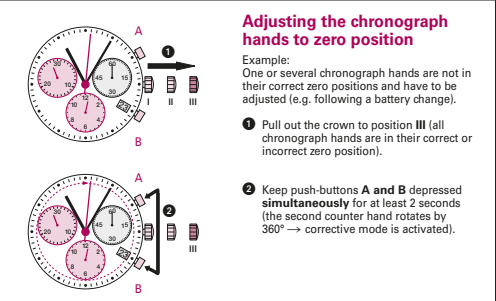

Adjusting the chronograph hands to zero position

Example:

One or several chronograph hands are not in their correct zero positions and have to be adjusted (e.g. following a battery change).

- Pull out the crown to position III (all chronograph hands are in their correct or incorrect zero position).
- Keep push-buttons A and B depressed **simultaneously** for at least 2 seconds (the second counter hand rotates by 360° → corrective mode is activated).

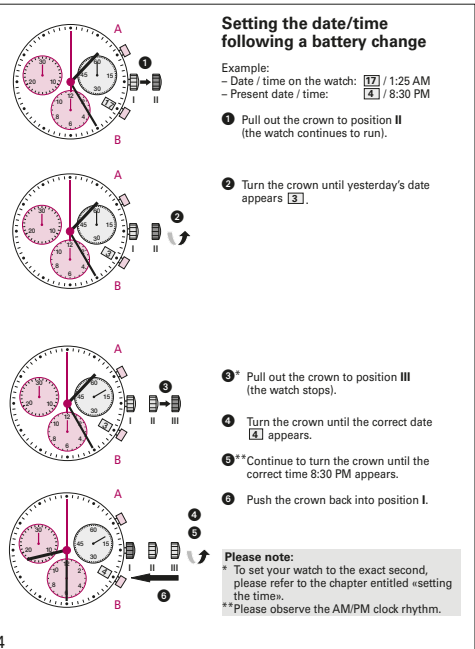

Setting the date/time following a battery change

Example:

- Date / time on the watch: [12] / 1:25 AM
- Present date / time: [4] / 8:30 PM

- Pull out the crown to position II (the watch continues to run).
- Turn the crown until yesterday's date appears [3].
- Pull out the crown to position III (the watch stops).
- Turn the crown until the correct date [4] appears.
- Continue to turn the crown until the correct time 8:30 PM appears.
- Push the crown back into position I.

Please note:

* To set your watch to the exact second, please refer to the chapter entitled «setting the time».
**Please observe the AM/PM clock rhythm.

04

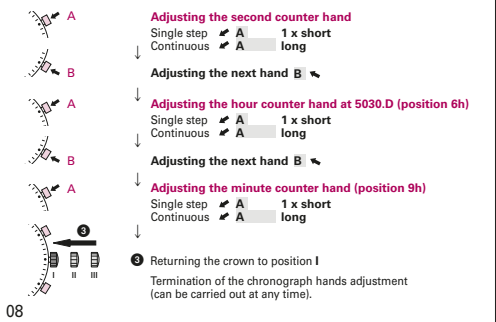

Adjusting the second counter hand

Single step ↖ A 1 x short
Continuous ↖ A long

Adjusting the next hand B

Single step ↖ A 1 x short
Continuous ↖ A long

Adjusting the hour counter hand at 5030.D (position 6h)

Single step ↖ A 1 x short
Continuous ↖ A long

Adjusting the next hand B

Single step ↖ A 1 x short
Continuous ↖ A long









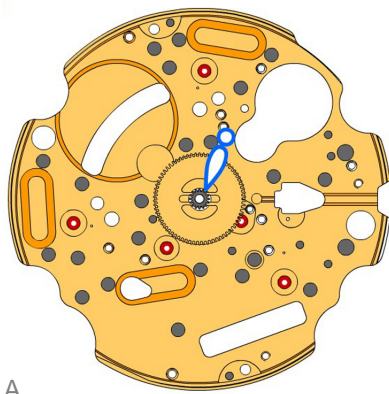
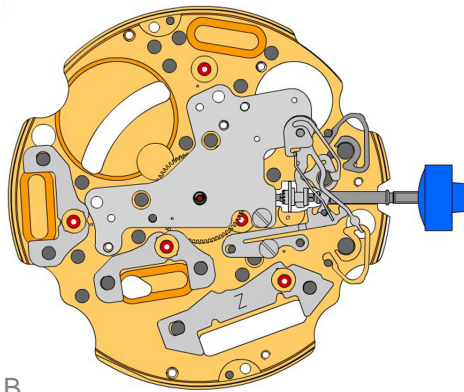







Adjusting the minute counter hand (position 9h)

Single step ↖ A 1 x short
Continuous ↖ A long





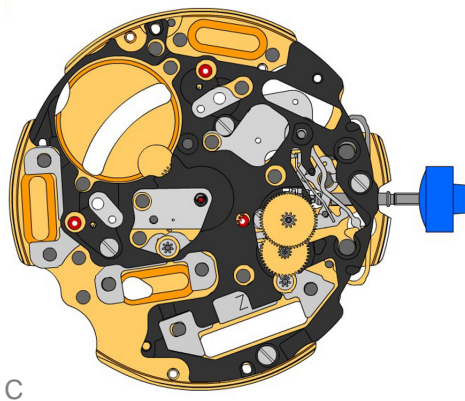

3 Returning the crown to position I
Termination of the chronograph hands adjustment (can be carried out at any time).

08





A

B

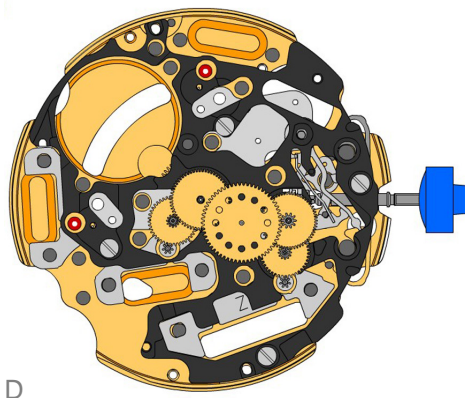
2000.574.G 1.		Main plate
3305.275.CO 2.		Cannon pinion with driver (Aig.1)
2030.017.CO 3.		Centre bridge Centre bridge held by 1 screw 4000.250.
4000.250 4.		Screw
3001.055.FI 5.		Sliding pinion
3000.177.CO 6.		Setting stem
3017.049 7.		Setting lever
3905.049 8.		Setting lever jumper (3 positions) Setting lever jumper held by 1 screw 4000.250.
4000.250 9.		Screw
3015.081 10.		Yoke (3 positions)
3905.067 11.		Yoke spring Tensioning the spring arm.
3406.030 12.		Pusher jumper B Put the grey jumper between the two posts on the further side.
3406.038 13.		Pusher jumper A Put the yellow jumper between the two posts on the closer side.
3622.040 14.		Stator Mark [Z] on stator.
3622.039 15.		Stator (counter 6h, 9h and chrono)
3622.039 16.		Stator (counter 6h, 9h and chrono)







3603.079 17.		Plastic bracket Plastic bracket held by 4 screws 4000.250.
4000.250 18.		Screw
3715.094.RK 19.		Rotor
3715.094.RK 20.		Rotor
3147.046.CO 21.		Intermediate wheel
3136.142.CO 22.		Second wheel (long)

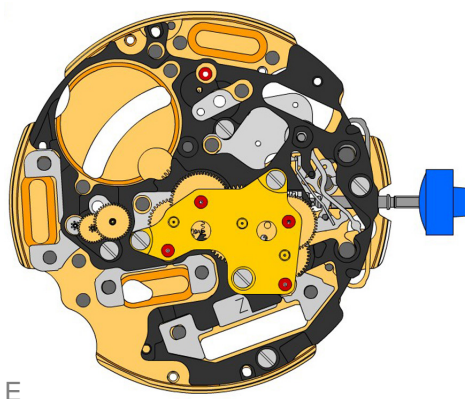

3147.047.CO 23.		Intermediate wheel (chrono)
3136.143.CO 24.		Chronograph wheel (Aig.1)
3122.056.CO 25.		Third wheel



2020.148.G 26.		Train wheel bridge Train wheel bridge held by 3 screws 4000.250.
4000.250 27.		Screw
3715.095.RK 28.		Rotor
3147.059.CO 29.		Intermediate wheel (counter)
3402.006.CO 30.		Minute counting wheel

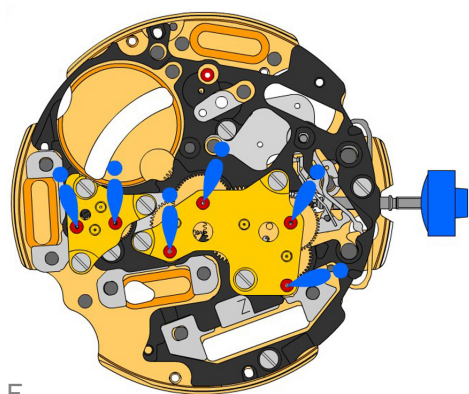



F

2020.149.G
31.  Counter train wheel bridge
Counter train wheel bridge held by 3 screws 4000.250.

4000.250
32.  Screw

4000.250
33.  Screw

3621.053.RK
34.  Coil
Attention: Please hold the coil only on the grey coil core. Coil held by 1 screw 4000.250.

3621.054.RK
35.  Coil (counter 9h, chrono)
Attention: Please hold the coil only on the grey coil core. Coil held by 1 screw 4000.250.

3621.054.RK
36.  Coil (counter 9h, chrono)
Attention: Please hold the coil only on the grey coil core. Coil held by 1 screw 4000.250.

4000.250
37.  Screw

3601.118
38.  Contact strip
Contact strip held by 1 screw 4000.250.

4000.250
39.  Screw

3603.034
40.  Battery insulator

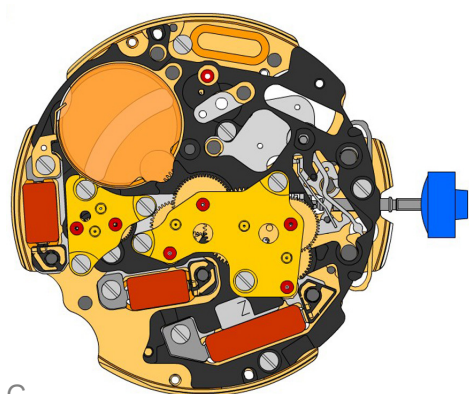

G

4000.248
41.  Screw

3603.069
42.  Circuit insulator

3601.107.G
43.  Pusher contact spring

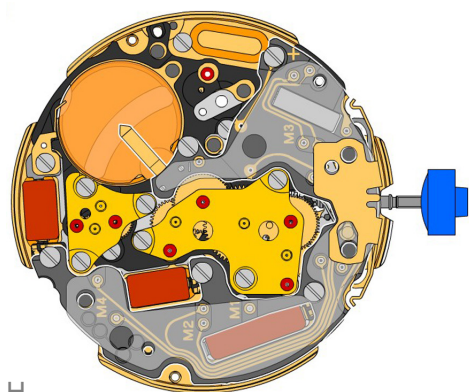

H

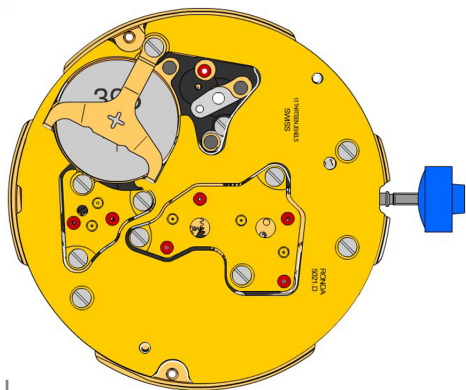

2130.137.G.M01.5021D
44.  **Electronic module cover**
Electronic module cover held by 3 screws 4000.250.



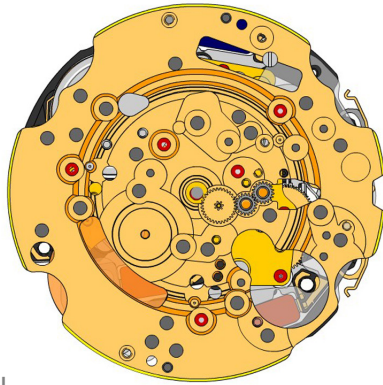

3600.010.HGF
45.  **Battery 395**

3601.109.G
46.  **Bridge +**
Bridge held by 1 screw 4000.250.

4000.250
47.  **Screw**







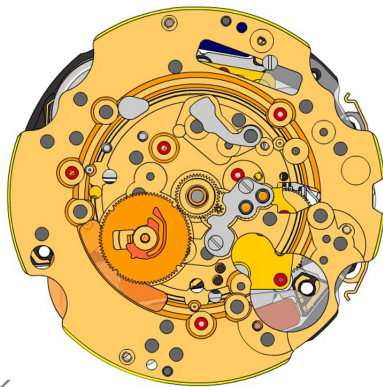

J

2000.574.G 48.		Main plate
3004.164 49.		Setting wheel
3004.164 50.		Setting wheel
3007.054.CO 51.		Minute wheel





K

2130.143 52.		Minute train bridge Minute train bridge held by 2 screws 4000.305.
4000.305 53.		Screw
3301.241 54.		Hour wheel (Aig.1)
3315.016 55.		Friction spring
3004.224.CO 56.		Date indicator driving wheel
3500.049 57.		Date jumper











L

3504.208.AB.1.A 58.		Date indicator (standard) Nick of the indicator at 3 o'clock.
2130.141 59.		Date indicator maintaining plate Date indicator maintaining plate held by 1 screw 4000.250.



M

3905.070 60.		Date jumper spring Insert the date jumper spring in the provided opening.
2130.140.G 61.		Date mechanism maintaining plate Date mechanism maintaining plate held by 2 screws 4000.250.
4000.250 62.		Screw
3506.072.G 63.		Dial support
8200 64.		Moebius 8200
9014 65.		Moebius 9014
124 66.		Jismaa 124
9020 67.		Moebius 9020

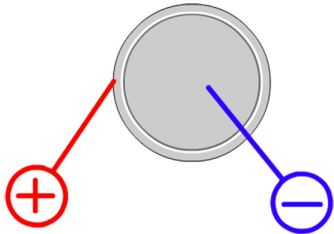

Battery	395
Voltage	1.55 V

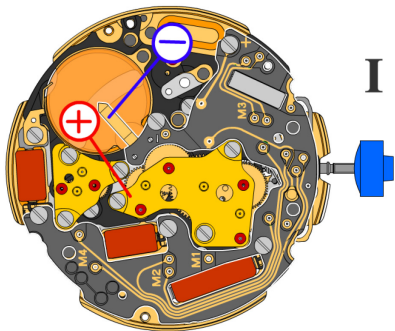

*Setting stem in position I, calendar not in gear,
60 s measuring interval for rate and consumption:*

Typical consumption	1.32 μA
Maximal consumption	1.65 μA
Rate	-10s/M. .. +20s/M.
Lower working voltage limit	1.20 V

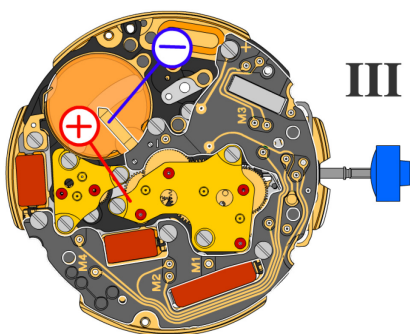

Setting stem in position III, 60 s measuring interval:

Typical consumption	0.10 μA
Maximal consumption	0.30 μA

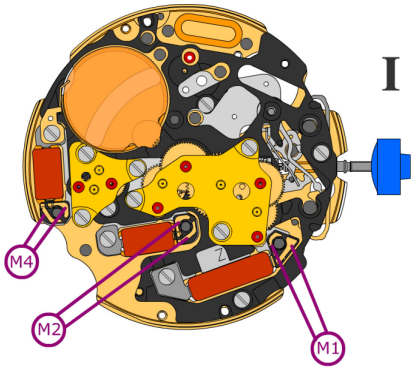

Coil resistance M1 **1.90 kΩ .. 2.10 kΩ**

Coil resistance M2 **1.68 kΩ .. 1.88 kΩ**

Coil resistance M4 **1.68 kΩ .. 1.88 kΩ**

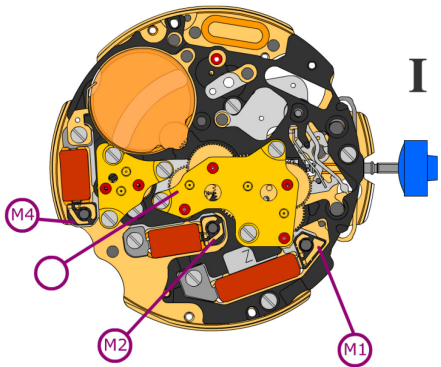

Coil resistances M1-M4 **∞ kΩ**

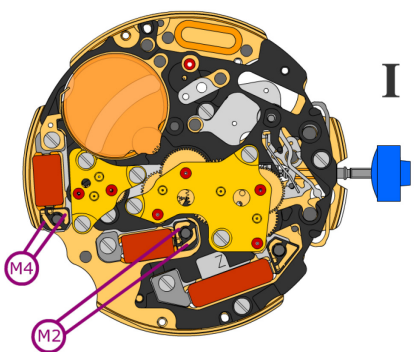

Signal generator (4.9 ms, 8 Hz):



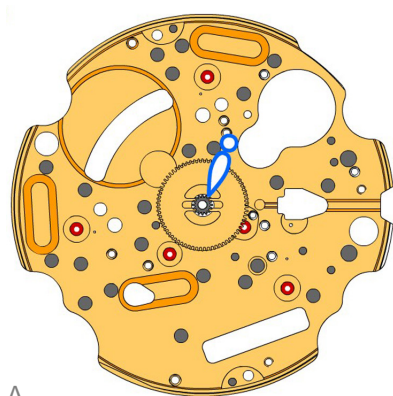



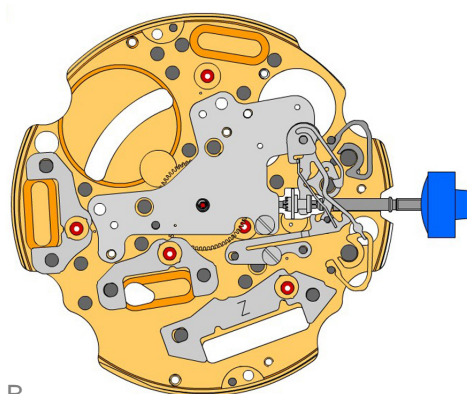









Lower working voltage limits M2-M4 **1.20 V**









A

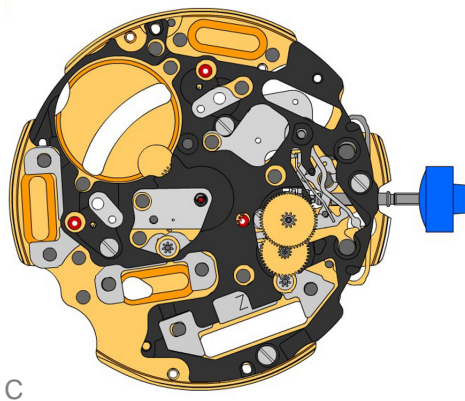





B

2000.574.G 1.		Main plate
3305.275.CO 2.		Cannon pinion with driver (Aig.1)
2030.017.CO 3.		Centre bridge Centre bridge held by 1 screw 4000.250.
4000.250 4.		Screw
3001.055.FI 5.		Sliding pinion
3000.177.CO 6.		Setting stem
3017.049 7.		Setting lever
3905.049 8.		Setting lever jumper (3 positions) Setting lever jumper held by 1 screw 4000.250.
4000.250 9.		Screw
3015.081 10.		Yoke (3 positions) Parts 3015.081 and 3905.067 must be exchanged together.
3905.067 11.		Yoke spring Tensioning the spring arm. Parts 3015.081 and 3905.067 must be exchanged together.
3406.030 12.		Pusher jumper B Put the grey jumper between the two posts on the further side.
3406.038 13.		Pusher jumper A Put the yellow jumper between the two posts on the closer side.
3622.040 14.		Stator Mark [Z] on stator.
3622.039 15.		Stator (counter 6h, 9h and chrono)
3622.039 16.		Stator (counter 6h, 9h and chrono)

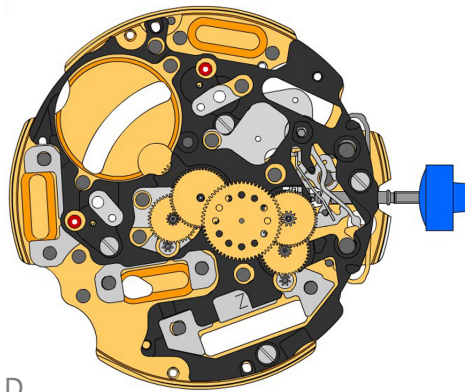



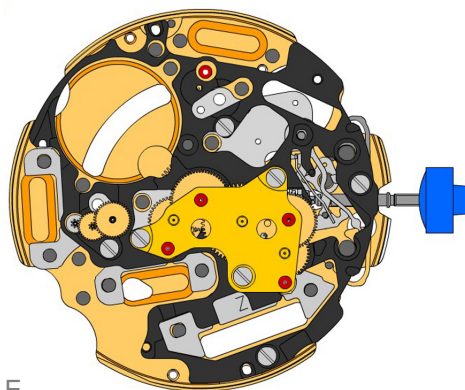

C

3603.079 17.		Plastic bracket Plastic bracket held by 4 screws 4000.250.
4000.250 18.		Screw
3715.094.RK 19.		Rotor
3715.094.RK 20.		Rotor
3147.046.CO 21.		Intermediate wheel
3136.142.CO 22.		Second wheel (long)

D



3147.047.CO 23.		Intermediate wheel (chrono)
3136.143.CO 24.		Chronograph wheel (Aig.1)
3122.056.CO 25.		Third wheel

E

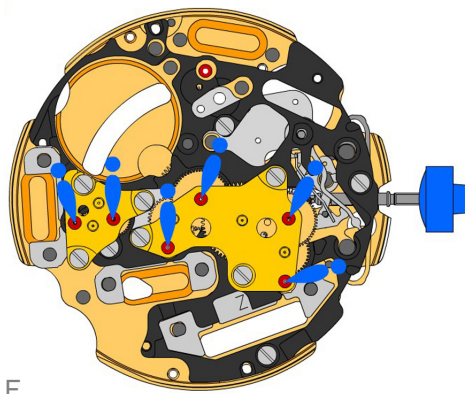
2020.148.G 26.		Train wheel bridge Train wheel bridge held by 3 screws 4000.250.
4000.250 27.		Screw
3715.095.RK 28.		Rotor Parts 3612.144.5021, 3715.095.RK and 3147.048.CO must be exchanged together.
3147.048.CO 29.		Intermediate wheel (counter) Parts 3612.144.5021, 3715.095.RK and 3147.048.CO must be exchanged together.
3402.006.CO 30.		Minute counting wheel





F

2020.149.G 31.		Counter train wheel bridge Counter train wheel bridge held by 3 screws 4000.250.
4000.250 32.		Screw

4000.250 33.		Screw
-----------------	---	--------------

3621.053.RK 34.		Coil Attention: Please hold the coil only on the grey coil core. Coil held by 1 screw 4000.250.
--------------------	---	---

3621.054.RK 35.		Coil (counter 9h, chrono) Attention: Please hold the coil only on the grey coil core. Coil held by 1 screw 4000.250.
--------------------	---	--

3621.054.RK 36.		Coil (counter 9h, chrono) Attention: Please hold the coil only on the grey coil core. Coil held by 1 screw 4000.250.
--------------------	---	--

4000.250 37.		Screw
-----------------	---	--------------

3601.118 38.		Contact strip Contact strip held by 1 screw 4000.250.
-----------------	--	---

4000.250 39.		Screw
-----------------	---	--------------

3603.034 40.		Battery insulator
-----------------	---	--------------------------

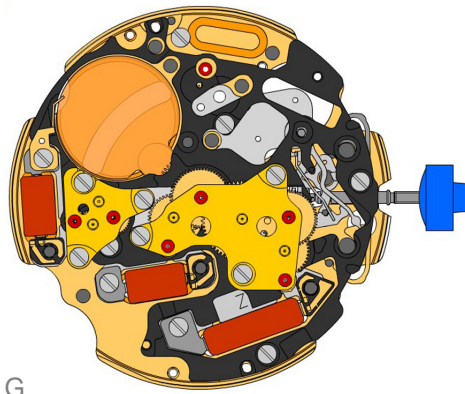

G

3612.144.5021 41.		Electronic module Electronic module held by 5 screws 4000.248. Electronic measurements may be realised now. Parts 3612.144.5021, 3715.095.RK and 3147.048.CO must be exchanged together.
----------------------	---	--

4000.248 42.		Screw
-----------------	---	--------------

3603.069 43.		Circuit insulator
-----------------	---	--------------------------

3601.107.G 44.		Pusher contact spring
-------------------	---	------------------------------

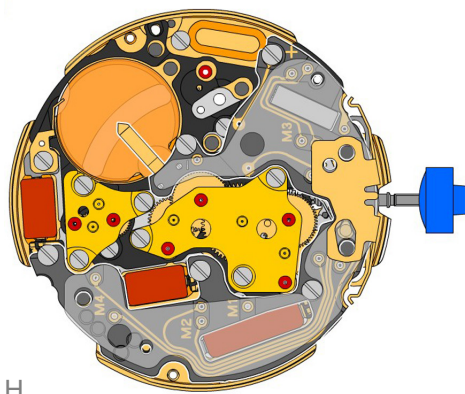

H

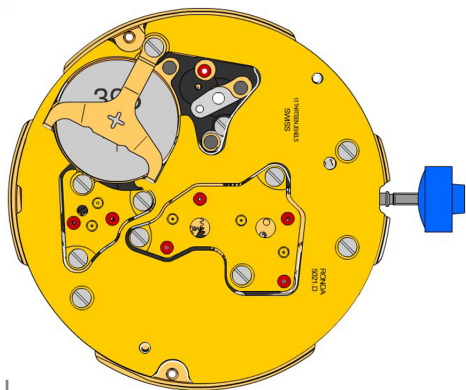

2130.137.G.M01.5021D
45.  **Electronic module cover**
Electronic module cover held by 3 screws 4000.250.



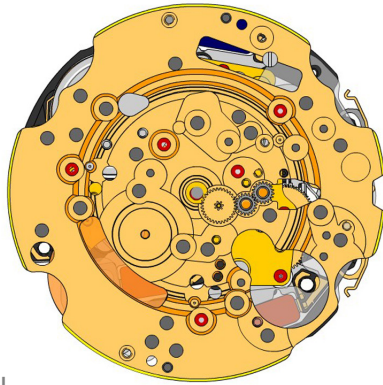

3600.010.HGF
46.  **Battery 395**

3601.109.G
47.  **Bridge +**
Bridge held by 1 screw 4000.250.

4000.250
48.  **Screw**







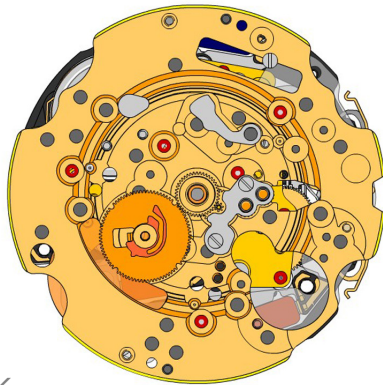

J

2000.574.G 49.		Main plate
3004.164 50.		Setting wheel
3004.164 51.		Setting wheel
3007.054.CO 52.		Minute wheel





K

2130.143 53.		Minute train bridge Minute train bridge held by 2 screws 4000.305.
4000.305 54.		Screw
3301.241 55.		Hour wheel (Aig.1)
3315.016 56.		Friction spring
3004.224.CO 57.		Date indicator driving wheel
3500.049 58.		Date jumper











L

3504.208.AB.1.A 59.		Date indicator (standard) Nick of the indicator at 3 o'clock.
2130.141 60.		Date indicator maintaining plate Date indicator maintaining plate held by 1 screw 4000.250.



M

3905.070 61.		Date jumper spring Insert the date jumper spring in the provided opening.
2130.140.G 62.		Date mechanism maintaining plate Date mechanism maintaining plate held by 2 screws 4000.250.
4000.250 63.		Screw
3506.072.G 64.		Dial support
8200 65.		Moebius 8200
9014 66.		Moebius 9014
124 67.		Jismaa 124
9020 68.		Moebius 9020

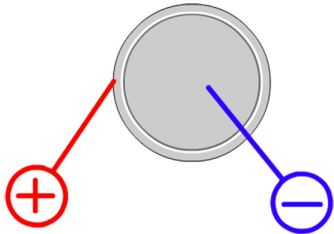

Battery	395
Voltage	1.55 V

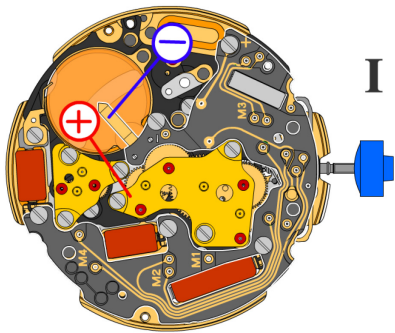

*Setting stem in position I, calendar not in gear,
60 s measuring interval for rate and consumption:*

Typical consumption	1.32 μA
Maximal consumption	1.65 μA
Rate	-10s/M. .. +20s/M.
Lower working voltage limit	1.20 V

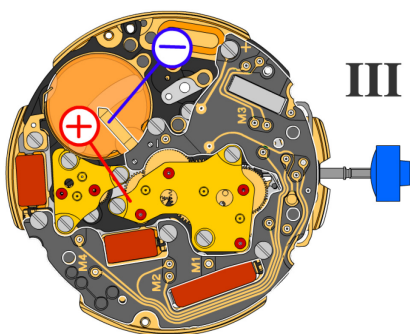

Setting stem in position III, 60 s measuring interval:

Typical consumption	0.10 μA
Maximal consumption	0.30 μA

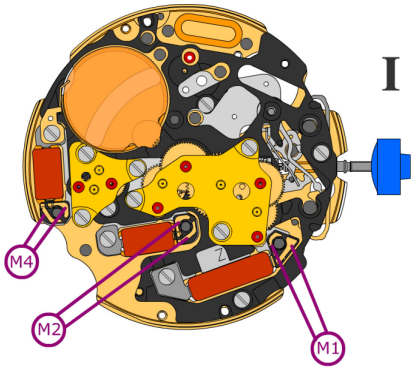

Coil resistance M1 **1.90 k Ω .. 2.10 k Ω**

Coil resistance M2 **1.68 k Ω .. 1.88 k Ω**

Coil resistance M4 **1.68 k Ω .. 1.88 k Ω**

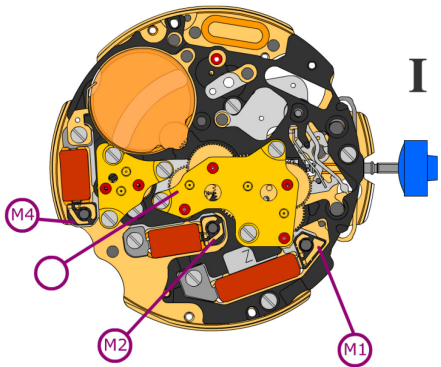

Coil resistances M1-M4 **∞ k Ω**

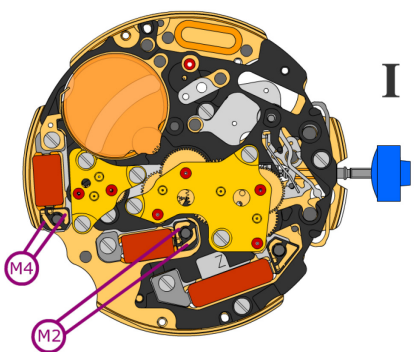

Signal generator (4.9 ms, 8 Hz):

Lower working voltage limits M2-M4 **1.20 V**