

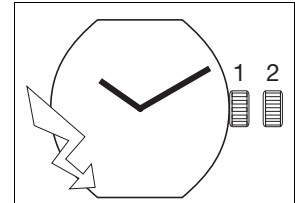

5 1/2" x 8" ETA 282.001

CT 282001 FDE 320630 10 11.12.2017

5 1/2" x 8" 13,00 x 18,20 mm



Hauteur sur mouvement	Höhe auf Werk	Movement height	1,20 mm
Hauteur sur pile	Höhe auf Batterie	Height on battery	1,40 mm
Nombre de rubis	Anzahl Rubine	Number of jewels	13
Fréquence	Frequenz	Frequency	32'768 Hz

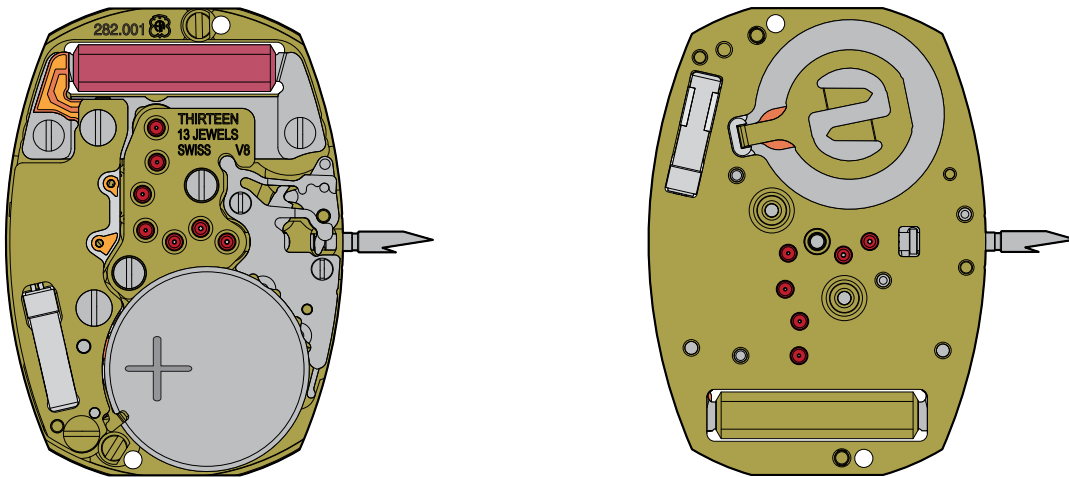

Les travaux de réparation et de révision ne doivent être effectués que par du personnel dûment formé.
Reparatur- und Revisionsarbeiten dürfen nur von ausgebildetem Fachpersonal ausgeführt werden.
The repair and reconditioning work must only be performed by properly trained personnel.



Informations générales



Avant de démarrer les travaux, veuillez svp étudier attentivement cette "*Communication technique*".



La protection des yeux est obligatoire pour toutes les interventions / tous les travaux sur le mouvement!



ETA SA décline toute responsabilité en cas de dommages du non respect de cette "*Communication technique*".

Exigences en matière de protection de l'environnement



Les dispositions légales en matière de traitement et d'élimination des déchets doivent être respectées lors de toutes les interventions / tous les travaux sur les mouvements!

En particulier, les produits de graissage et de nettoyage néfastes pour l'environnement doivent être éliminés selon les règles!



Les **substances de nature à polluer l'eau** doivent être entreposées, transportées, récupérées et éliminées dans des récipients adéquats.

Elles ne doivent en aucun cas polluer le sol ou être évacuées dans les réseaux de canalisation!

Explication des symboles



Attention! Risque de dégât matériel!

Ci-après quelques instructions à suivre obligatoirement pour éviter tout dégât matériel!



Ci-après quelques conseils d'utilisations et informations importantes.

Allgemeine Informationen



Diese "*Technische Mitteilung*" ist **vor** dem Beginn der Arbeiten genauestens zu studieren.



Für sämtliche Arbeiten am und mit dem Uhrwerk ist ein Augenschutz obligatorisch!



Für Schäden, welche durch Nichtbeachtung dieser "*Technischen Mitteilung*" entstehen, haftet die ETA SA nicht.

Umweltschutz-Vorschriften



Bei allen Arbeiten am und mit dem Uhrwerk sind die gesetzlichen Vorschriften zur ordnungsgemässen Verwertung und Beseitigung der Abfälle einzuhalten!

Insbesondere sind umweltgefährdende Schmier- und Reinigungsmittel ordnungsgemäss zu entsorgen!



Wassergefährdende Stoffe müssen in geeigneten Behältern aufbewahrt, transportiert, aufgefangen und entsorgt werden.

Diese dürfen nicht den Boden belasten oder in die Kanalisation gelangen!

Symbolerklärung



Achtung! Gefahr von Sachschäden!

Hier folgen wichtige Hinweise, die zur Vermeidung von Sachschäden unbedingt beachtet werden müssen!



Hier folgen Anwendungstipps und wichtige Informationen.

General information



Before starting work, please study this "*Technical communication*" carefully.



Eye protection is obligatory for all operations / work on the movement!



ETA SA disclaims any liability in case of damage arising from failure to observe this "*Technical communication*".

Environmental protection requirements



The legal provisions relating to waste handling and disposal must be observed in all operations / work on the movement!

In particular, lubricating and cleaning products harmful to the environment must be disposed of in accordance with the rules!



Substances prone to cause water pollution must be stored, transported, collected and disposed of in appropriate vessels.

They must not pollute the soil or be poured into sewage systems!

Explanation of symbols



Caution! Risk of material damage!

Below are some obligatory instructions for preventing any material damage!



Below are some application tips and important informations.

Liste des fournitures - Bestandteilliste - List of components

Pos	Numéro d'article Artikelnummer Article number		Liste des fournitures	Bestandteilliste	List of components
1	Var		Platine, empierrée	Werkplatte, mit Steinen	Main plate, jewelled
1-1	Var	2x	Fixateur de cadran	Zifferblatthalter	Dial fastener
2	7613226013865		Pignon coulant	Kupplungstrieb	Sliding pinion
3	Var		Tige de mise à l'heure	Stellwelle	Handsetting stem
4	7613226057760		Tirette	Winkelhebel	Setting lever
5	7613226034884		Bascule de pignon coulant	Kupplungstriebhebel	Yoke
6	7613226006645		Sautoir de tirette	Winkelhebelraste	Setting lever jumper
7	7613226047600		Stator	Stator	Stator
8	Var		Roue des heures	Stundenrad	Hour wheel
9	7613226042483		Ressort-friction de la roue des heures	Friktionsfeder für Stundenrad	Friction spring for hour wheel
10	7613226011267		Roue de minuterie	Wechselrad	Minute wheel
11	7613226018846		Roue de transmission de roue intermédiaire	Übertragungsrad für Zwischenrad	Transmission wheel for intermediate wheel
12	7613226050051		Roue moyenne	Kleinbodenrad	Third wheel
13	Var		Roue de centre	Minutenrad	Centre wheel
14	7613226042117		Rotor	Rotor	Rotor
15	7613226004733		Roue intermédiaire	Zwischenrad	Intermediate wheel
16	7613226051232		Renvoi, monté	Zeigerstellrad, montiert	Setting wheel, assembled
17	Var		Pont de rouage, empierré	Räderwerkbrücke, mit Steinen	Train wheel bridge, jewelled
18	7613226027169		Bobine, montée	Spule, montiert	Coil, assembled
19	7613226057807		Isolateur de contact	Isolation für Kontakt	Contact insulator
20	7613226056831		Bride -	Minusbügel	Bridle -
21	7613226044289		isolateur de bride d'alimentation	Isolation für Stromversorgungsbügel	Power connection insulator
22	7613226041226		Bride +	Bügel +	Bridle +
23	Var		Module électronique	Elektronik-Baugruppe	Electronic module
24	7613226008984		Pile	Batterie	Battery
25	7613226054493		Isolateur de cadran	Isolation für Zifferblatt	Dial insulator
900	7613226123441		Vis tête cônica nickelée, poli feutre	Senkschraube vernickelt filzpoliert	Countersunk screw nickel plated polished by felt
		2x	- Pos. 6: Vis de sautoir de tirette	- Pos. 6: Schraube für Winkelhebelraste	- Pos. 6: Screw for setting lever jumper
901	7613226123427		Vis tête cônica nickelée, poli feutre	Senkschraube vernickelt filzpoliert	Countersunk screw nickel plated polished by felt
		2x	- Pos. 17: Vis de pont de rouage	- Pos. 17: Schraube für Räderwerkbrücke	- Pos. 17: Screw for train wheel bridge
		2x	- Pos. 18: Vis de bobine	- Pos. 18: Schraube für Spule	- Pos. 18: Screw for coil
902	7613226123434		Vis tête cônica nickelée, poli feutre	Senkschraube vernickelt filzpoliert	Countersunk screw nickel plated polished by felt
		2x	- Pos. 23: Vis de module électronique	- Pos. 23: Schraube für Elektronik-Baugruppe	- Pos. 23: Screw for electronic module
903	7613226106512		Vis à portée, doré, poli feutre	Ansatzschraube, vergoldet, filzpoliert	Shouldered screw, gold plated, polished by felt
		1x	- Pos. 23: Vis de module électronique	- Pos. 23: Schraube für Elektronik-Baugruppe	- Pos. 23: Screw for electronic module
	Var		Variante	Variante	Variant

L'interchangeabilité et les variantes se trouvent sur ETA ONLINE SHOP (EOS) :

www.eta.ch

- Customer Service
- Customer Service Portal

Die Austauschbarkeit und Varianten finden Sie im ETA ONLINE SHOP (EOS):

www.eta.ch











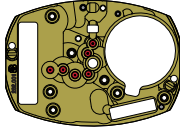















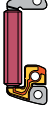

- Customer Service
- Customer Service Portal

Interchangeability and variants can be found on the ETA ONLINE SHOP (EOS):

www.eta.ch

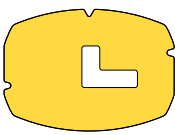
- Customer Service
- Customer Service Portal

Fournitures - Bestandteile - Materials

										
1 Var	1-1 Var	2	3 Var	4	5	6	7			
										
8 Var	9	10	11	12	13 Var	14	15	16	17 Var	18
										
19	20	21	22	23 Var	24	25				
										
900	901	902	903							

Ordre d'assemblage - Montager Reihenfolge - Order of assembly:
 Mécanisme de mise à l'heure - Zeigerwerkmechanismus - Handsetting mechanism

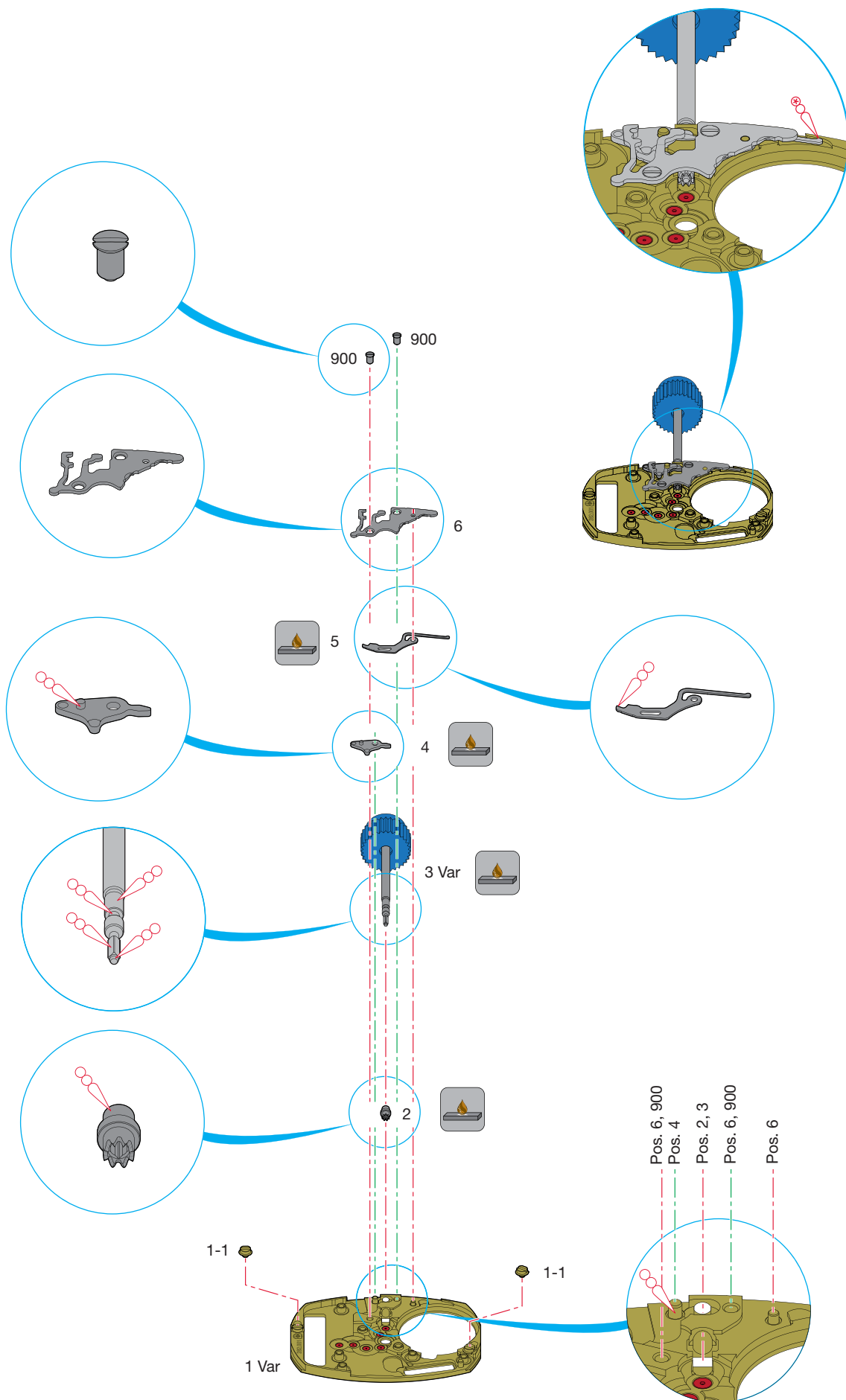

Montage du mécanisme de mise à l'heure

(Liste des fournitures par ordre d'assemblage)

Zusammenstellen des Zeigerwerkmechanismus

(Bestandteilliste in Montagereihenfolge)

Assembling of the handsetting mechanism

(Parts listed in order of assembly)

1 Var	4	900 (2x)
2	5	
3 Var	6	

Lubrification - Schmierung - Lubrication

 Huile épaisse
Dickflüssiges Öl
Thick oil

**Moebius
HP-1300**

 Très faible quantité
Sehr kleine Menge
Very small quantity

**Moebius
HP-1300**



Si les pièces à assembler ne sont pas neuves, les composants existants doivent être traités à la Moebius Fixodrop ES/BS 8981 avant le réassemblage.

Wenn keine Neuteile montiert werden, müssen die vorhandenen Teile vor der Wiedermontage mit Moebius Fixodrop ES/BS 8981 epilamisiert werden.

If the pieces to be assembled are not new, existing components must be treated with Moebius Fixodrop ES/BS 8981 before reassembly.

Moebius Fixodrop ES/BS 8981



Volatile
Flüchtig
Volatile

Produit très volatile!

A garder après usage dans des récipients fermés et étanches.

Sehr flüchtiges Produkt!

Nach Gebrauch in geschlossenen und luftdichten Behältern aufbewahren.

Very volatile product!

Keep in closed and airtight containers after usage.

Ordre d'assemblage - Montager Reihenfolge - Order of assembly:
 Rouage - Räderwerk - Wheel train

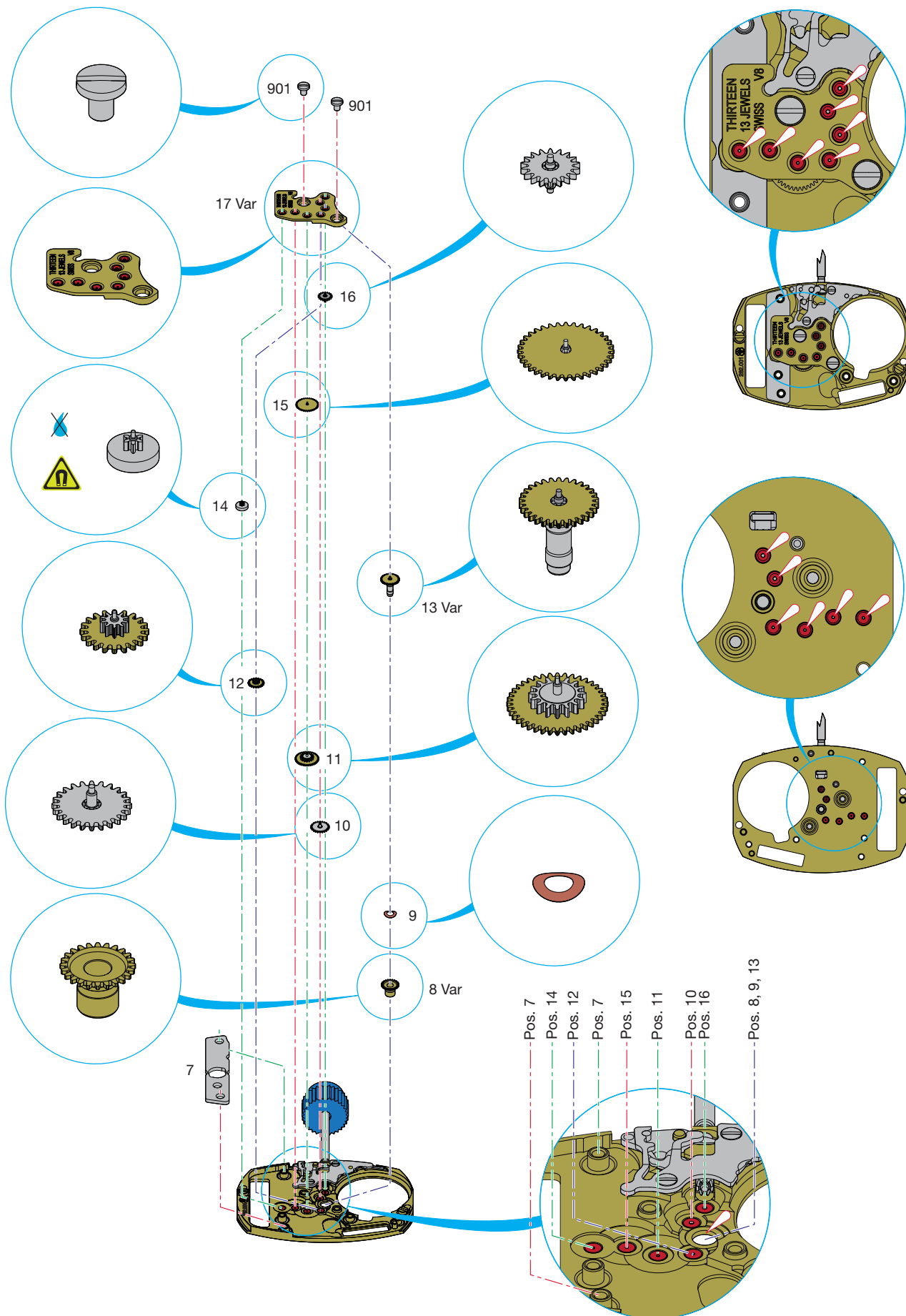

Montage du rouage

(Liste des fournitures par ordre d'assemblage)

Zusammenstellen des Räderwerks

(Bestandteilliste in Montagereihenfolge)

Assembling of the wheel train

(Parts listed in order of assembly)

7	11	15
8 Var	12	16
9	13 Var	17 Var
10	14	901 (2x)

Lubrification - Schmierung - Lubrication

 Huile fine
Dünnflüssiges Öl **Moebius 9014**
Fine oil

Ne pas laver. Si la pièce est très sale ou rouillée, l'échanger par une fourniture d'origine livrée pré lubrifiée par ETA SA.



Nicht waschen. Sollte das Stück sehr verschmutzt oder rostig sein, ist es gegen ein von ETA SA vorgeöltes Original-Stück zu tauschen.

Do not wash. If the part is very dirty or rusty, it should be exchanged for an original part which is lubricated and delivered by ETA SA.



Avant le montage, s'assurer qu'aucun copeau métallique ni aucune salissure n'est présent sur l'aimant.

Vor dem Montieren kontrollieren, dass keine metallischen Späne oder Verunreinigungen auf dem Magneten zurückgeblieben sind.

Before assembly, check that no metal filings or impurities have remained on the magnet.

Ordre d'assemblage - Montager Reihenfolge - Order of assembly:
 Module électronique - Elektronik-Baugruppe - Electronic module

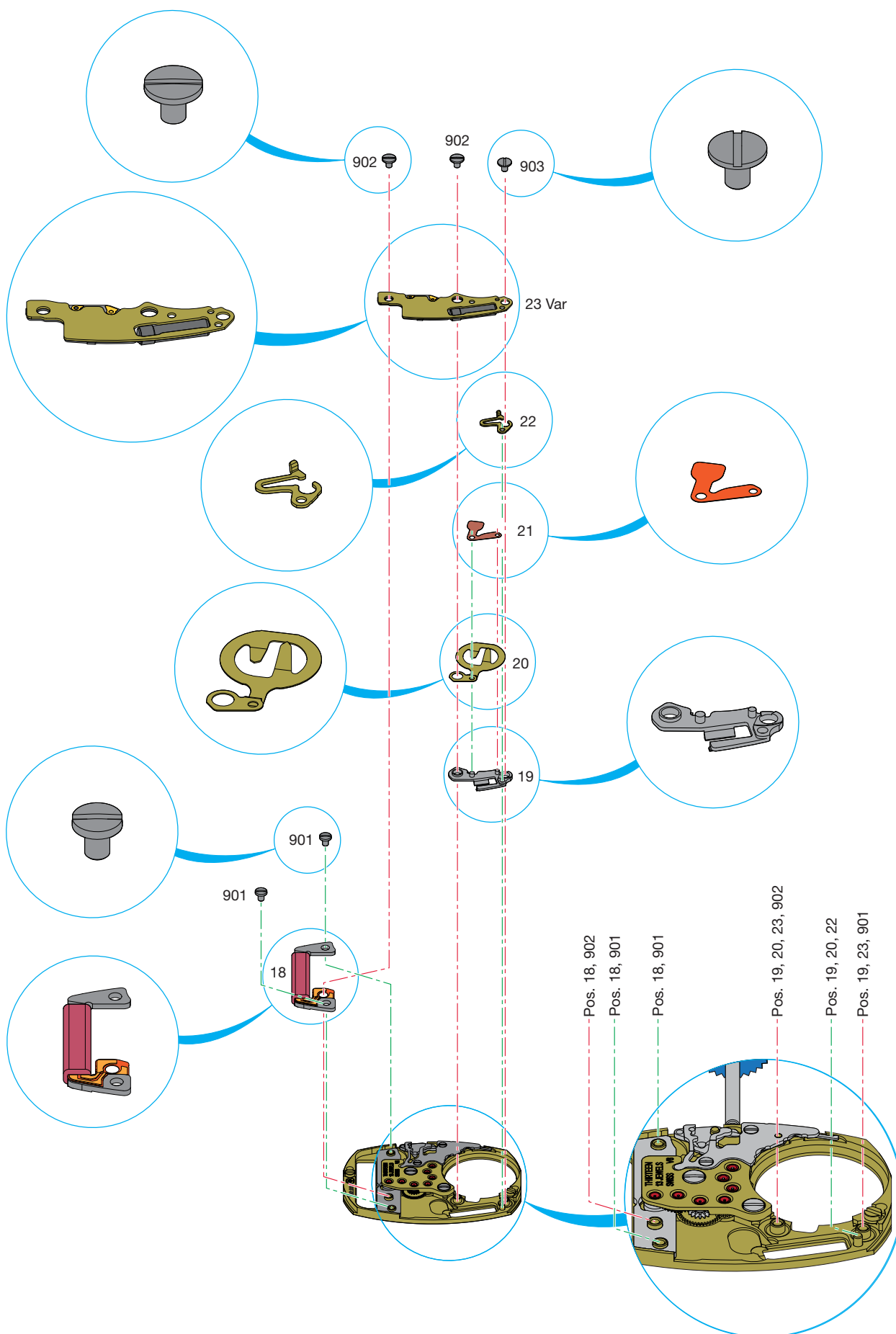

Montage du module électronique

(Liste des fournitures par ordre d'assemblage)

Zusammenstellen der Elektronik-Baugruppe

(Bestandteilliste in Montager Reihenfolge)

Assembling of the electronic module

(Parts listed in order of assembly)

18	20	23 Var
901 (2x)	21	902 (2x)
19	22	903 (1x)

Ordre d'assemblage - Montager Reihenfolge - Order of assembly:
Pile - Batterie - Battery

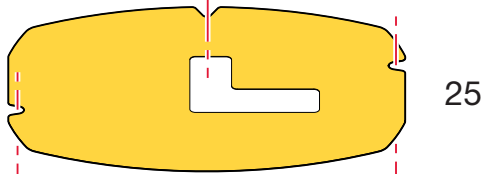

25

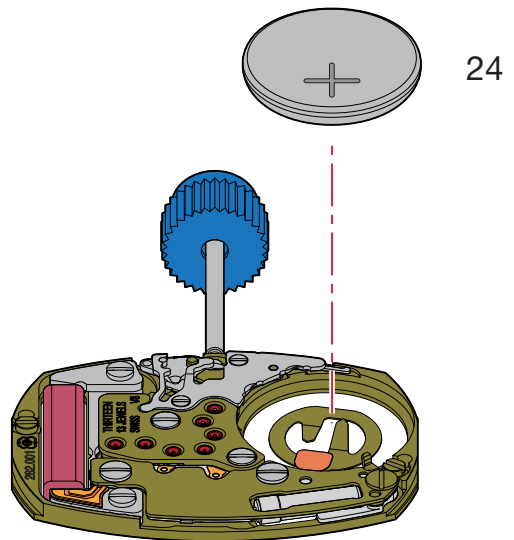
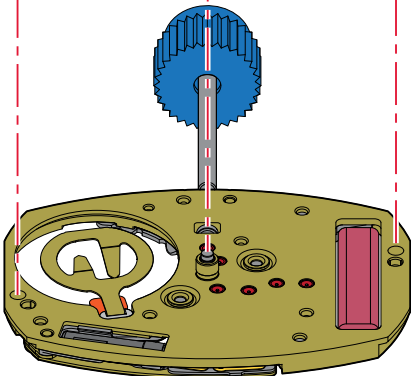

24

Montage de la pile

(Liste des fournitures par ordre d'assemblage)

Zusammenstellen der Batterie

(Bestandteilliste in Montagereihenfolge)

Assembling of the battery

(Parts listed in order of assembly)

24

25



Pièce du client

Teil vom Kunden

Part of the customer

Contrôles électriques - Elektrische Kontrollen - Electrical Tests

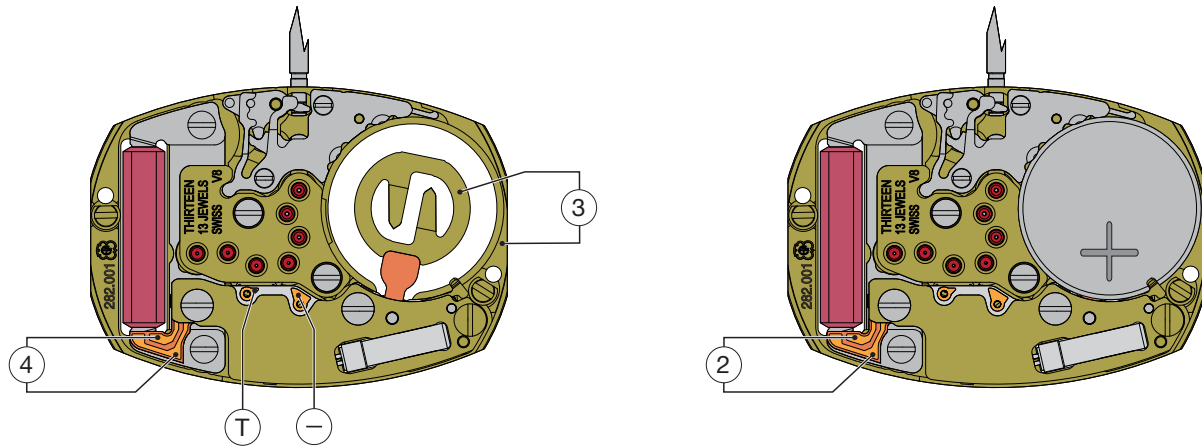

Position Messpunkt Position	Echelle de mesure Einstellung Messgerät Setting of apparatus	Mesure Messung Measurement	Contrôle Kontrolle Test	Remarques Bemerkungen Remarks
1	2 V (Ri ≥ 10 kΩ/V)	1,55 V	Tension de la pile. Spannung der Batterie. Battery voltage.	Mesure avec pile. Messung mit Batterie. Measurement with battery.
2	2 V (Ri ≥ 10 kΩ/V)	L'aiguille du multimètre oscille en sens + et - . Zeiger im Messgerät pulsiert im + und - Sinn. Hand of measuring apparatus oscillates in + and - direction.	Impulsion à la sortie du circuit intégré. Ausgangsimpulse am integrierten Schaltkreis. Impulses at output of integrated circuit. 5 / min.	Mesure avec une pile contrôlée. Messung mit kontrollierter Batterie. Measurement with controlled battery.
3	2 V	≤ 1,30 V Mettre en contact le point T et la piste - . Commande du moteur avec 16 pas/s . T Punkt mit der - Spur verbinden. Motorantrieb mit 16 Schritten/s. Connect T point with the - conductor. Motor driven with 16 steps/s.	Limite inférieure de la tension de fonctionnement. Untere Funktionsspannungsgrenze. Lower working voltage limit.	Mesure sans pile, alimentation extérieure variable. Messung ohne Batterie, mit variabler Speisung von aussen. Measurement without battery, with variable external power supply.
	10 μA	≤ 0,50 μA	Consommation du mouvement. Stromaufnahme Uhrwerk. Power consumption of movement.	Mesure sans pile, avec alimentation extérieure 1,55 V. Messung ohne Batterie, mit Speisegerät 1,55 V. Measurement without battery, with power-supply unit 1.55 V.
*4	10 kΩ	1,0-1,5 kΩ	Résistance de la bobine. Spulenwiderstand. Resistance of coil.	
Ohmmètres avec tension de mesure supérieure à 0,40 V inappropriés, tension recommandée 0,20 V. Ohmmeter mit Prüfspannung über 0,40 V ungeeignet, empfohlene Spannung 0,20 V. Ohmmeter with a test voltage higher than 0.40 V unsuitable, recommended voltage 0.20 V.				

Les tests doivent être effectués dans une température ambiante entre 20° C et 25° C.
 Die Tests sind bei einer Umgebungstemperatur zwischen 20° C und 25° C durchzuführen.
 The tests must be conducted at an ambient temperature of between 20° C and 25° C.

Contrôle de la marche instantanée

La période d'inhibition est de
60 secondes.

La mesure de la marche ne peut se faire qu'avec un appareil permettant une mesure pendant 60 secondes ou même un multiple de 60 secondes.

La mesure de la marche doit avoir lieu à une température comprise entre 20° C et 25° C.

Alimentation

Pile à l'oxyde d'argent
U = 1,55 V, type "Low drain".

Ø 7,90 mm, hauteur 1,25 mm
Capacité 9,5 mAh (Renata)

Renata, Energizer
No 346, SR 712 SW.

Kontrolle des momentanen Ganges

Die Inhibitions-Periode beträgt
60 Sekunden.

Der Gang kann nur mit einem Instrument gemessen werden, das eine Messung während einer Zeitspanne von 60 Sekunden oder einem Vielfachen davon erlaubt.

Die Gangmessung muss bei einer Temperatur von 20° C bis 25° C erfolgen.

Stromversorgung

Silberoxyd-Batterie
U = 1,55 V, Typ "Low Drain".

Ø 7,90 mm, Höhe 1,25 mm
Kapazität 9,5 mAh (Renata)

Renata, Energizer
Nr. 346, SR 712 SW.

Checking the intantaneous rate

The Inhibition periode is
60 seconds.

The rate must be checked with an instrument that allows measuring over one or several periods of 60 seconds.

Check the rate at a temperature between 20° C and 25° C.

Current supply

Silver oxide battery
U = 1.55 V, "Low Drain" type.

Ø 7.90 mm, height 1.25 mm
Capacity 9,5 mAh (Renata)

Renata, Energizer
No. 346, SR 712 SW.

Pose de la pile

Glisser la pile contre la bride de contact ①. Presser la pile au fond de son logement ②. La bride + maintient la pile en place.

La pincette ne doit pas être conductrice d'électricité!

Batterie einsetzen

Die Batterie gegen den Batteriehaltebügel ① einlegen. Danach die Batterie in das Batteriefach drücken ②. Der Finger des Bügels + fixiert die Batterie in der Halterung.

Die Pinzette darf nicht elektrisch leitend sein!

Fitting the battery

Slide the battery against the contact strip ①. Press the battery firmly into its mounting ②. The bridle + keeps the battery in position.

The tweezers must not be electrically conductive!

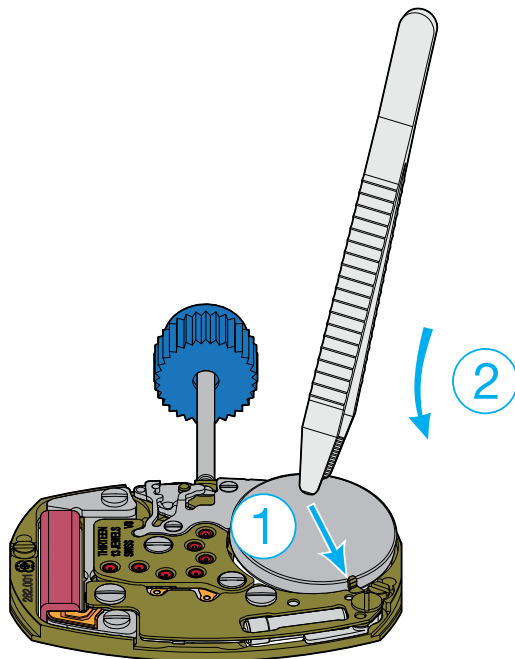

Retrait de la pile

Glisser une brucelle ① entre la platine et la pile (voir dessin) et faire levier sous celle-ci en écartant très légèrement la bride + vers le haut ②. Sortir la pile ③.

La pincette ne doit pas être conductrice d'électricité!

Batterie herausnehmen

Führen Sie eine Pinzette ① zwischen Werkplatte und Batterie ein (siehe Abbildung). Heben Sie die Batterie mit leichtem Druck nach oben ②. Nehmen Sie die Batterie ③ heraus.

Die Pinzette darf nicht elektrisch leitend sein!

Removing the battery

Insert tweezers ① between main plate and battery (see drawing) and lift out the battery by gently lifting back ②. Remove the battery ③.

The tweezers must not be electrically conductive!

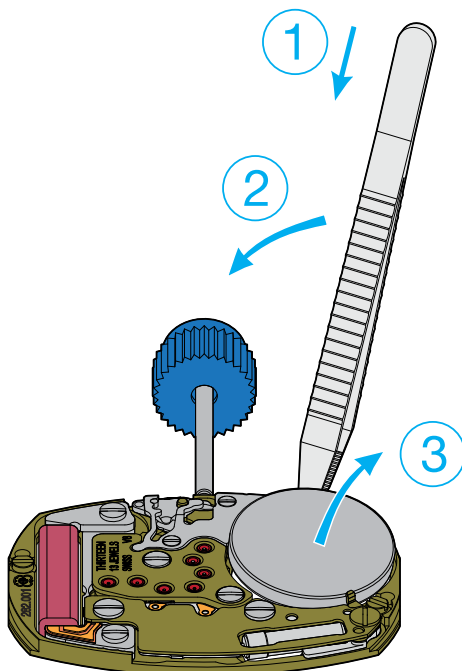

Extraction de la tige de mise à l'heure

Repousser obligatoirement la tige de mise à l'heure en position 1 (neutre) avant de presser sur le point à droite de la tirette.

Entfernen der Stellwelle

Erst die Stellwelle in Position 1 (neutral) drücken, dann zum Lösen der Stellwelle auf den Punkt rechts auf dem Winkelhebel drücken.

Extracting the stem

The handsetting stem must be pushed back to position 1 (neutral) before pressing on the point lying on the right sider of the setting lever.

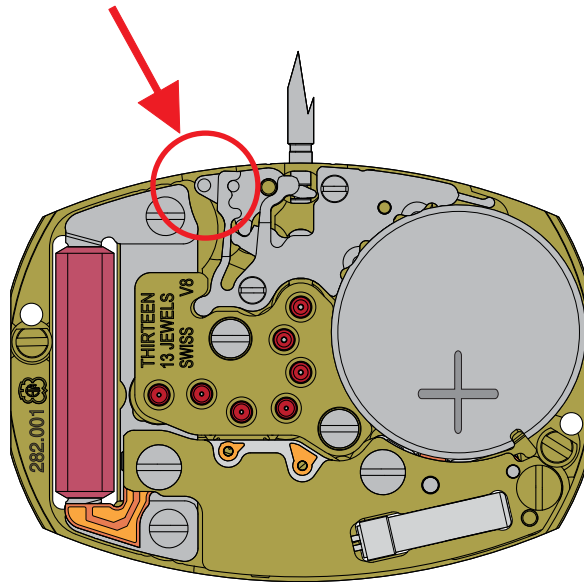



Pour des informations concernant les aiguillages voir:

Information Habillage

Plan:
AIGUILLAGES
ZEIGERWERKHÖHEN
HAND FITTING HEIGHTS



Für Informationen betreffend der Zeigerwerkhöhen siehe:

Fabrikanten Information

Zeichnung:
AIGUILLAGES
ZEIGERWERKHÖHEN
HAND FITTING HEIGHTS



For information regarding hand fitting heights see:

Manufacturing Information

Drawing:
AIGUILLAGES
ZEIGERWERKHÖHEN
HAND FITTING HEIGHTS

Cette page est laissée vide
intentionnellement en cas d'impression
au format A3.

Diese Seite wird absichtlich leer
gelassen für den Fall, dass im
A3-Format gedruckt wird.

This page has deliberately been
left blank in case of A3 format
printing.

Modifications comparées aux versions précédentes du document**Änderungen gegenüber vorhergehenden Dokumentversionen****Modifications compared with previous document versions**

Version	Date Datum Date	Modification	Änderung	Modification	Page Seite Page
10	11.12.2017	Update document	Update Dokument	Update document	1–15
09	28.08.2015	Ajout ou suppression numéro GTIN et variante	GTIN Nummer und Variante zusätzlich oder entfernt	Addition or removal GTIN number and variant	3
		Nouvelles illustrations	Neue Illustrationen	New illustrations	5–15
08	08.06.2015	Impulsion à la sortie du circuit intégré	Ausgangsimpulse am integrierten Schaltkreis	Impulses at output of integrated circuit	16
07	10.02.2015	Adaptation	Anpassung	Adaptation	1–3
06	09.02.2015	Adaptation	Anpassung	Adaptation	20
05	10.06.2014	Nouvelle adresse	Neue Adresse	New address	1, 4, 24
		Nouveau plan	Neue Zeichnung	New drawing	20
04	16.05.2011	Extraction de la tige de mise à l'heure	Entfernen der Stellwelle	Extracting the stem	19
		Pose/Retrait de la pile	Batterie einsetzen/herausnehmen	Fitting/Removing the battery	18
		Contrôle de la marche instantanée	Kontrolle des momentanen Ganges	Checking the instantaneous rate	17
		Impulsion à la sortie	Ausgangsimpulse	Impulses at output	16
		Ordre d'assemblage	Montagereihenfolge	Order of assembly	6–15
03	01.10.2010	Ajout lubrifications sur dessin	Zusatz Schmierungen auf Zeichnung	Addition lubrications on drawing	5
		Nouveau layout	Neues Layout	New layout	1–12
02	23.09.2003	Version de base	Basis Version	Basic version	--

Sous réserve de toutes modifications.

Änderungen vorbehalten.

All modifications reserved.

Ce document se trouve sur le Customer Service Portal (CSP) :**www.eta.ch**

- Customer Service
- Customer Service Portal
- Documents techniques

Dieses Dokument finden Sie im Customer Service Portal (CSP) :**www.eta.ch**

- Customer Service
- Customer Service Portal
- Technische Dokumente

This document can be found on the Customer Service Portal (CSP):**www.eta.ch**

- Customer Service
- Customer Service Portal
- Technical Documents



ETA^{SA}
MANUFACTURE HORLOGÈRE SUISSE
DEPUIS 1793

SC MARKETING & COMMUNICATION

Bahnhofstrasse 9
2540 Grenchen
Switzerland

Phone +41 (0)32 655 71 11
Fax +41 (0)32 655 71 74

contact@eta.ch
www.eta.ch